

# DENTAL INSTRUMENTS

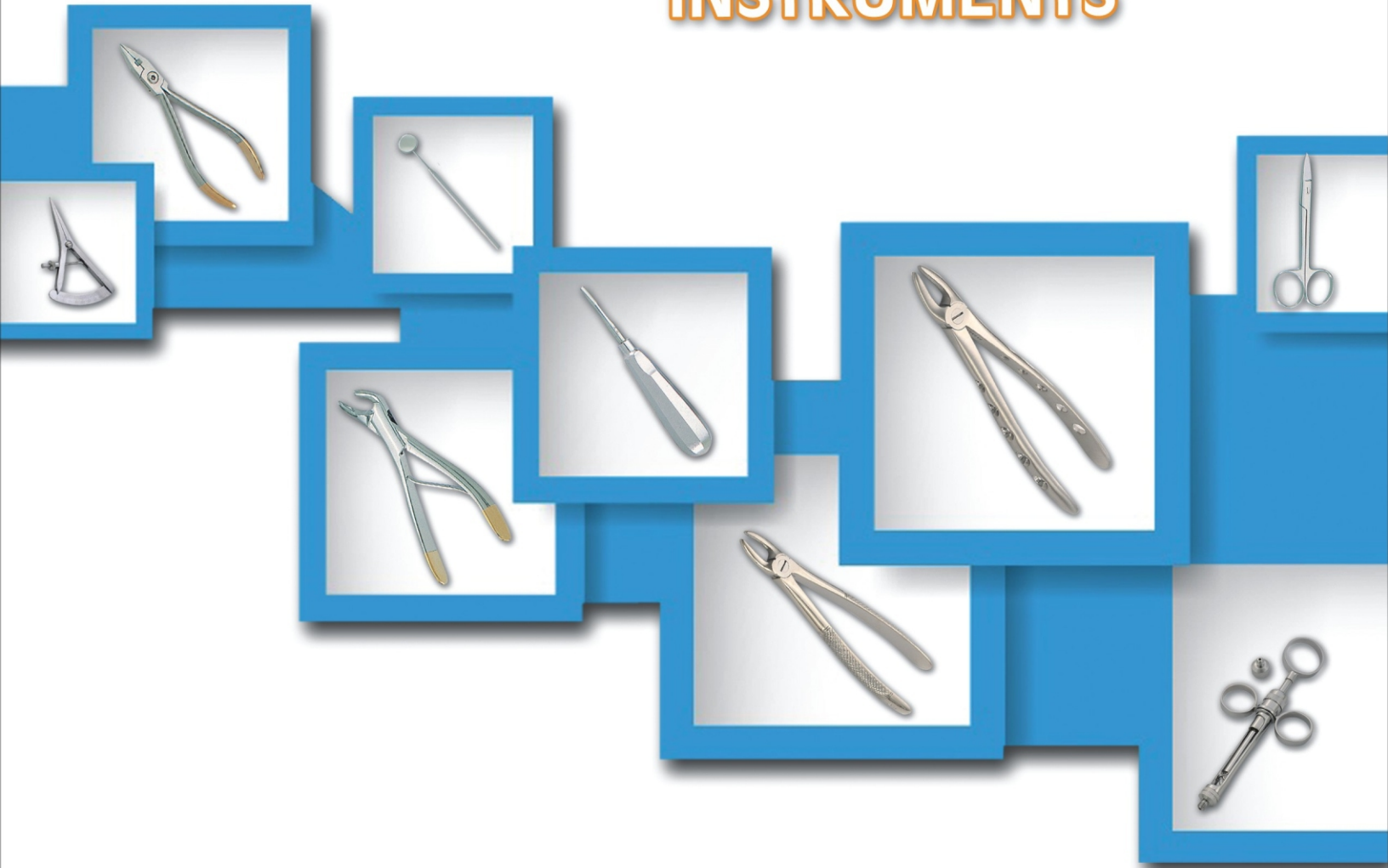

 **UMED**  
**INSTRUMENTS**

[WWW.UMED.COM.PK](http://WWW.UMED.COM.PK)

NEW  
EDITION

DENTAL INSTRUMENTS

**Root Elevators Set, Extraction Set ●●●**

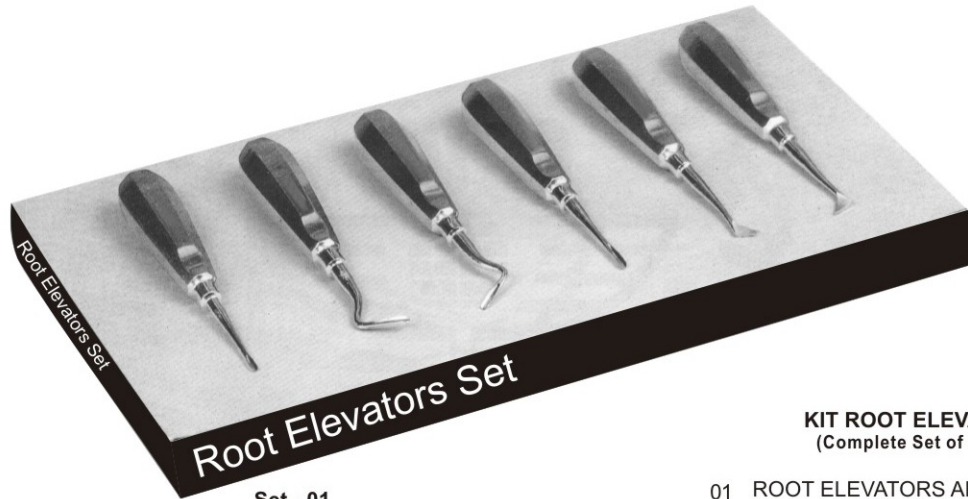

Set - 01

**KIT ROOT ELEVATORS**  
(Complete Set of 6 Pcs.)

- |    |                       |         |
|----|-----------------------|---------|
| 01 | ROOT ELEVATORS APICAL | Fig.301 |
| 02 | ROOT ELEVATORS APICAL | Fig.302 |
| 03 | ROOT ELEVATORS APICAL | Fig.303 |
| 04 | ROOT ELEVATORS SELDIN | Fig.34S |
| 05 | ROOT ELEVATORS CRYER  | Fig.44  |
| 06 | ROOT ELEVATORS CRYER  | Fig.45  |



Set - 02

**EXTRACTION AND ORAL SURGERY**  
(Complete Set of 9Pcs.)

- |    |                          |          |
|----|--------------------------|----------|
| 01 | EXTRACTING FORCEPS       | Fig. 67A |
| 02 | EXTRACTING FORCEPS       | Fig. 51A |
| 03 | EXTRACTING FORCEPS       | Fig. 33  |
| 04 | EXTRACTING FORCEPS       | Fig. 79  |
| 05 | ROOT ELEVATORS FLOHR     | Fig. 20  |
| 06 | ROOT ELEVATORS FLOHR     | Fig. 238 |
| 07 | ROOT ELEVATORS FLOHR     | Fig. 239 |
| 08 | MAYO HEGAR NEEDLE HOLDER | 16 cm    |
| 09 | MATHIEU NEEDLE HOLDER    | 14 cm    |





●●● Extraction Set

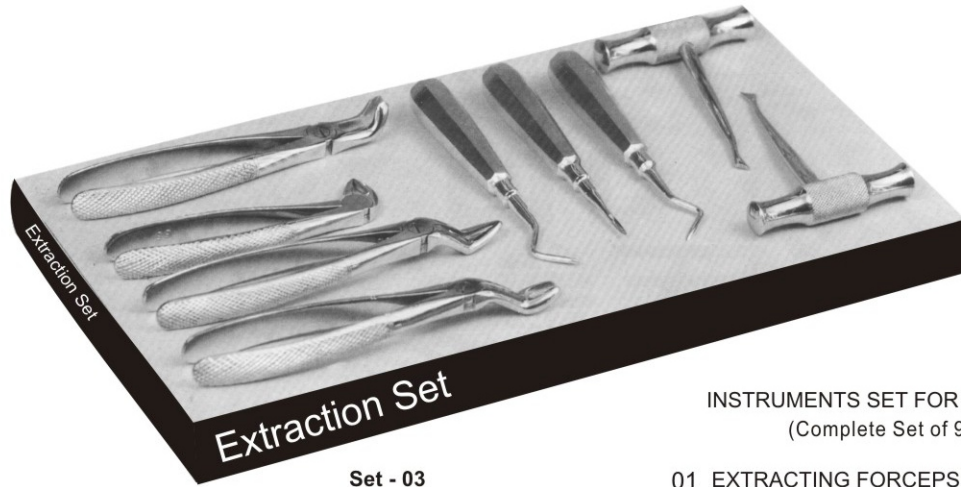

Set - 03

INSTRUMENTS SET FOR EXTRACTION  
(Complete Set of 9 Pcs.)

- |    |                       |          |
|----|-----------------------|----------|
| 01 | EXTRACTING FORCEPS    | Fig. 67A |
| 02 | EXTRACTING FORCEPS    | Fig. 51A |
| 03 | EXTRACTING FORCEPS    | Fig. 33  |
| 04 | EXTRACTING FORCEPS    | Fig. 79  |
| 05 | ROOT ELEVATORS FLOHR  | Fig. 20  |
| 06 | ROOT ELEVATORS FLOHR  | Fig. 238 |
| 07 | ROOT ELEVATORS FLOHR  | Fig. 239 |
| 08 | ROOT ELEVATORS WINTER | Fig. 320 |
| 09 | ROOT ELEVATORS WINTER | Fig. 321 |



Set - 04

INSTRUMENTS SET FOR EXTRACTION  
(Complete Set of 8 Pcs.)

- |    |                    |          |
|----|--------------------|----------|
| 01 | EXTRACTING FORCEPS | Fig. 1   |
| 02 | EXTRACTING FORCEPS | Fig. 17  |
| 03 | EXTRACTING FORCEPS | Fig. 18  |
| 04 | EXTRACTING FORCEPS | Fig. 79  |
| 05 | EXTRACTING FORCEPS | Fig. 67A |
| 06 | EXTRACTING FORCEPS | Fig. 51A |
| 07 | EXTRACTING FORCEPS | Fig. 13  |
| 08 | EXTRACTING FORCEPS | Fig. 22  |





Set - 05



INSTRUMENTS SET FOR EXTRACTION  
(Complete Set of 8 Pcs.)

- 01 EXTRACTING FORCEPS Fig. 1
- 02 EXTRACTING FORCEPS Fig. 17
- 03 EXTRACTING FORCEPS Fig. 18
- 04 EXTRACTING FORCEPS Fig. 79
- 05 EXTRACTING FORCEPS Fig. 67A
- 06 EXTRACTING FORCEPS Fig. 51A
- 07 EXTRACTING FORCEPS Fig. 13
- 08 EXTRACTING FORCEPS Fig. 22

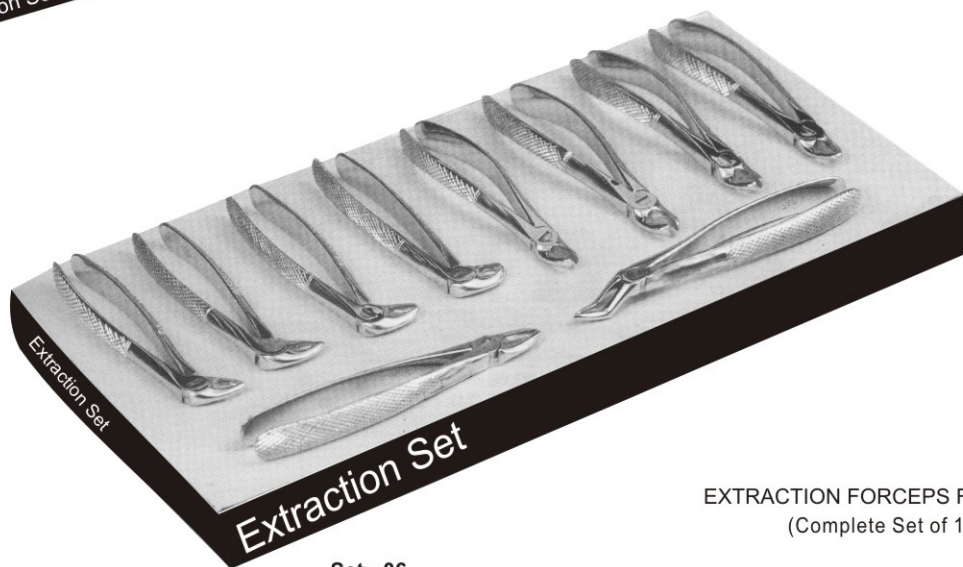

Set - 06



EXTRACTION FORCEPS FOR CHILDREN  
(Complete Set of 10 Pcs.)

- 01 EXTRACTING FORCEPS FINO Fig. 37
- 02 EXTRACTING FORCEPS FINO Fig. 39
- 03 EXTRACTING FORCEPS FINO Fig. 39L
- 04 EXTRACTING FORCEPS FINO Fig. 39R
- 05 EXTRACTING FORCEPS FINO Fig. 51S
- 06 EXTRACTING FORCEPS FINO Fig. 13S
- 07 EXTRACTING FORCEPS FINO Fig. 30S
- 08 EXTRACTING FORCEPS FINO Fig. 33S
- 09 EXTRACTING FORCEPS FINO Fig. 22S
- 10 EXTRACTING FORCEPS FINO Fig. 38



● ● ● Extraction Set

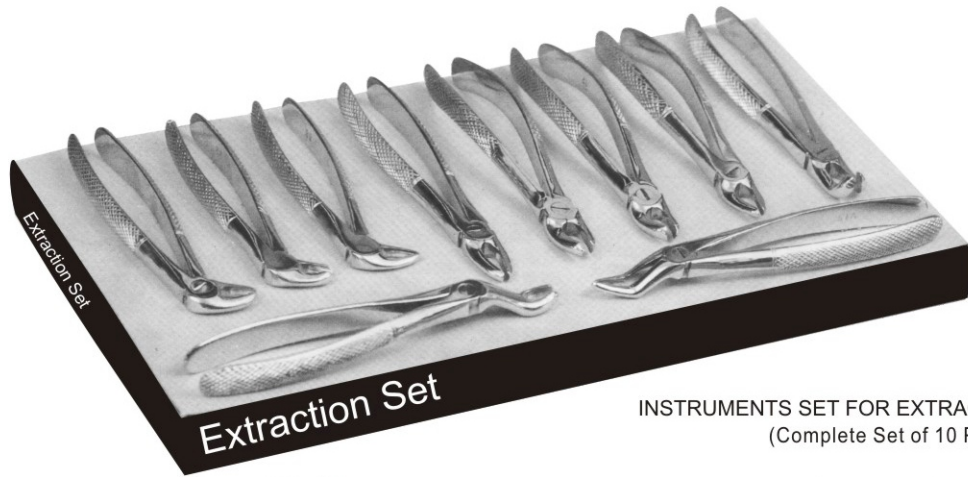

Set - 07

INSTRUMENTS SET FOR EXTRACTING FORCEPS  
(Complete Set of 10 Pcs.)

- |    |                    |          |
|----|--------------------|----------|
| 01 | EXTRACTING FORCEPS | Fig. 2   |
| 02 | EXTRACTING FORCEPS | Fig. 7   |
| 03 | EXTRACTING FORCEPS | Fig. 51A |
| 04 | EXTRACTING FORCEPS | Fig. 17  |
| 05 | EXTRACTING FORCEPS | Fig. 18  |
| 06 | EXTRACTING FORCEPS | Fig. 67A |
| 07 | EXTRACTING FORCEPS | Fig. 13  |
| 08 | EXTRACTING FORCEPS | Fig. 33  |
| 09 | EXTRACTING FORCEPS | Fig. 22  |
| 10 | EXTRACTING FORCEPS | Fig. 79  |

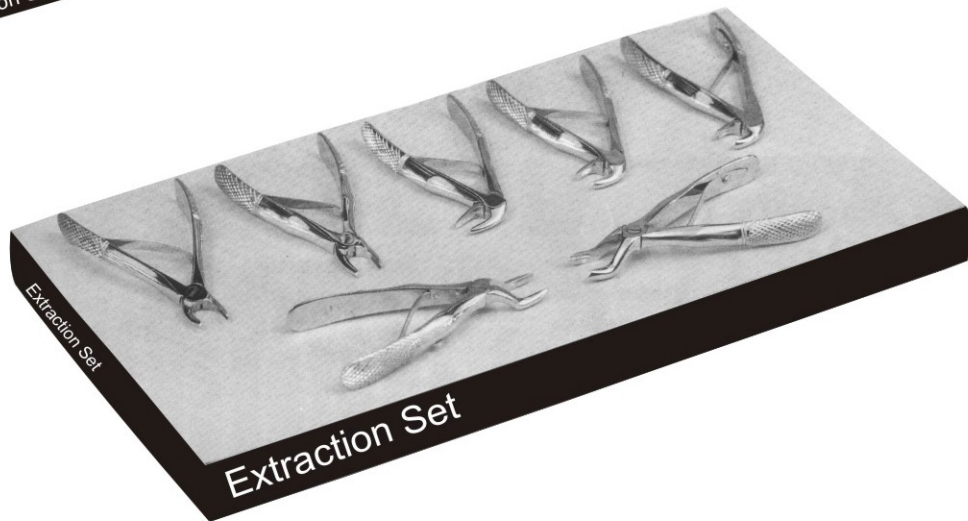

Set - 08

EXTRACTING FORCEPS SET FOR CHILDREN KLEIN PATTERN  
(Complete Set of 7 Pcs.)

- |    |                             |          |
|----|-----------------------------|----------|
| 01 | EXTRACTING FORCEPS CHILDREN | Fig. 5   |
| 02 | EXTRACTING FORCEPS CHILDREN | Fig. 6   |
| 03 | EXTRACTING FORCEPS CHILDREN | Fig. 7   |
| 04 | EXTRACTING FORCEPS CHILDREN | Fig. 137 |
| 05 | EXTRACTING FORCEPS CHILDREN | Fig. 139 |
| 06 | EXTRACTING FORCEPS CHILDREN | Fig. 3   |
| 07 | EXTRACTING FORCEPS CHILDREN | Fig. 51S |





**EXTRACTING FORCEPS** ENGLISH PATTERN ●●●

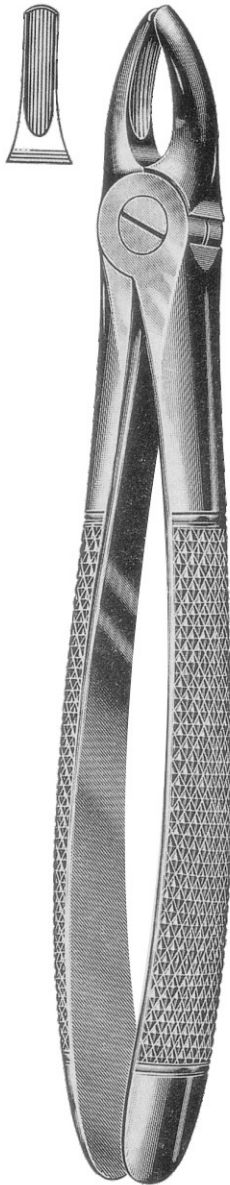

201-0001  
Fig.1  
Upper centrals  
& canines

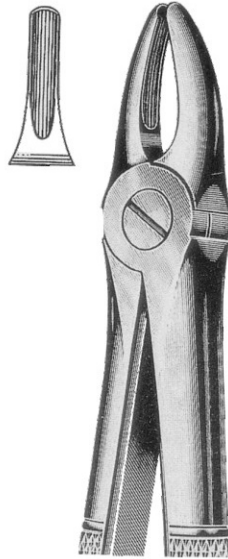

201-0002  
Fig.2  
Upper laterals  
& becuspids  
& bicuspid

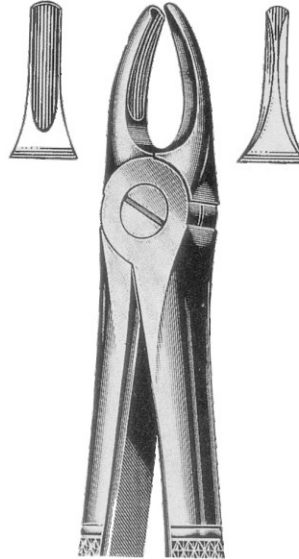

201-0003  
Fig.3  
Upper incisors  
& canines

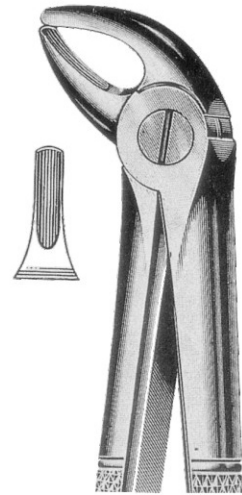

201-0004  
Fig.4  
Lower incisors  
& canines

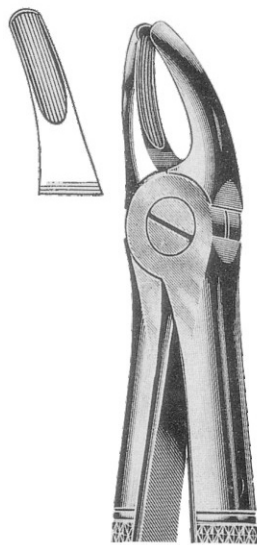

201-0005  
Fig.7  
Upper primolars

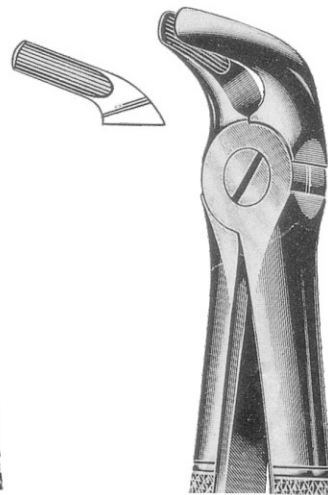

201-0006  
Fig.8  
Lower primolars

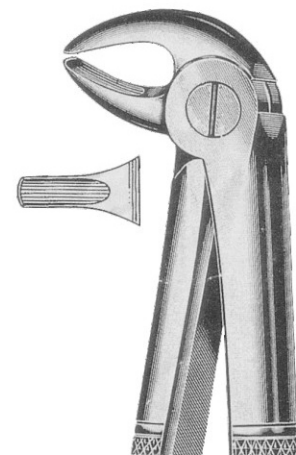

201-0007  
Fig.13  
Lower primolars

●●● **EXTRACTING FORCEPS** ENGLISH PATTERN



201-0008  
Fig.17  
Right upper molars

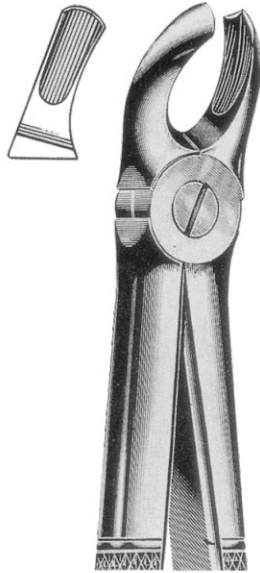

201-0009  
Fig.18  
Left upper molars

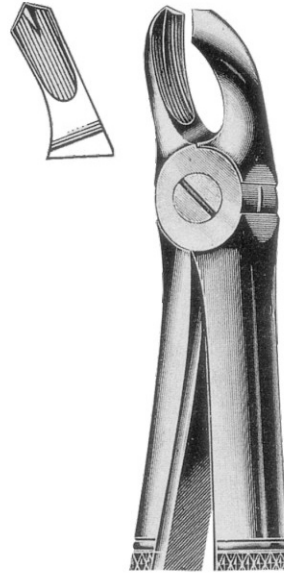

201-0010  
Fig.18A  
Upper molars

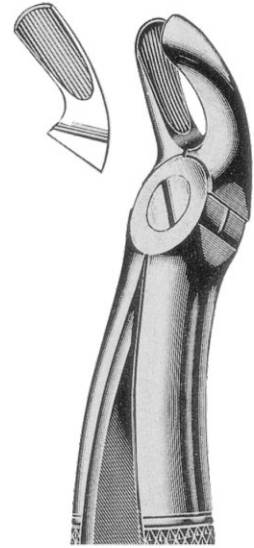

201-0011  
Fig.18A  
Upper wisdoms

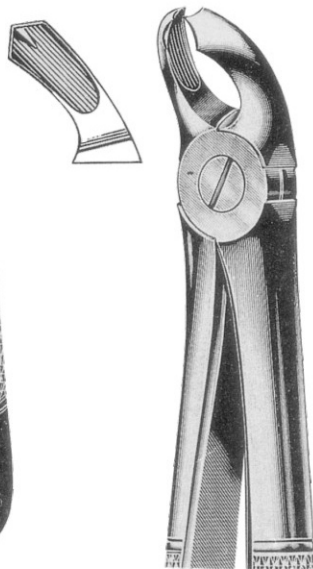

201-0012  
Fig.20  
Lower wisdoms

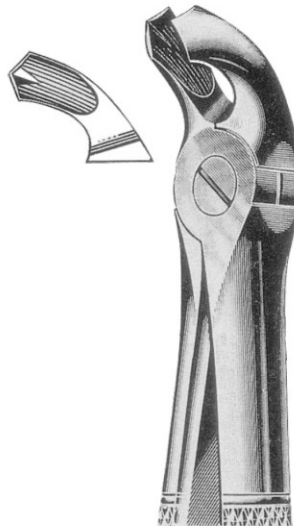

201-0013  
Fig.21  
Lower molar

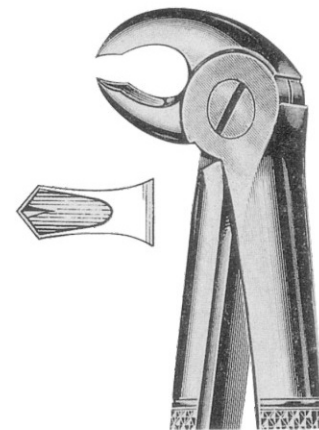

201-0014  
Fig.22  
Lower molars  
Hawk's bills

EXTRACTING FORCEPS ENGLISH PATTERN ●●●



201-0015  
Fig.23  
Right lower molars

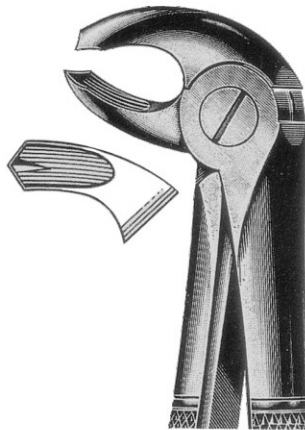

201-0016  
Fig.24  
Left lower molars

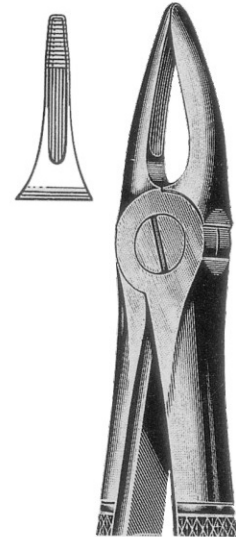

201-0017  
Fig.29  
Upper root & incisors

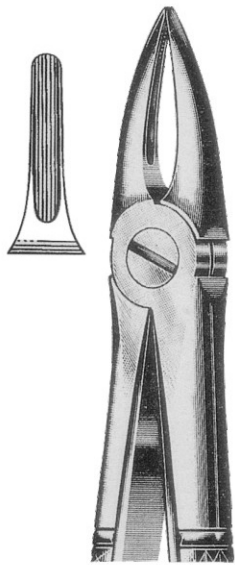

201-0018  
Fig.29N  
Roots of upper incisors

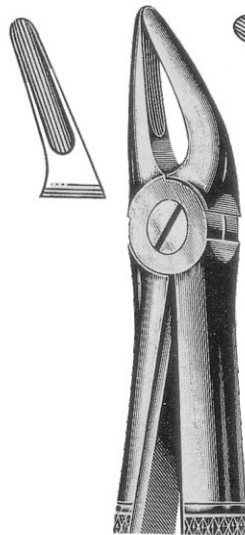

201-0019  
Fig.30  
Upper roots & incisors

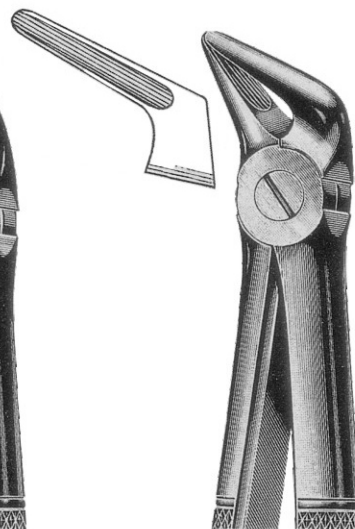

201-0020  
Fig.31  
Lower roots

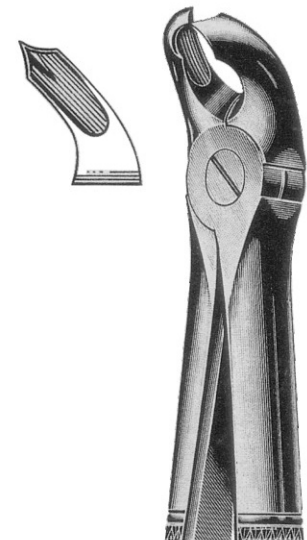

201-0021  
Fig.32  
Lower molars



●●● **EXTRACTING FORCEPS** ENGLISH PATTERN

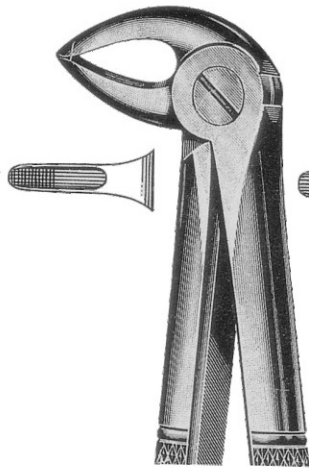

201-0022  
Fig.33  
Lower roots

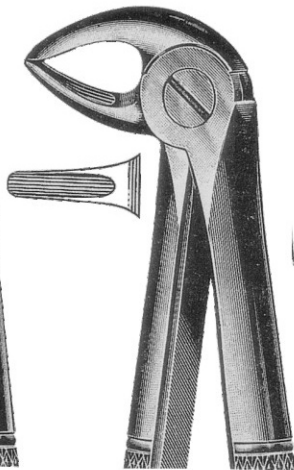

201-0023  
Fig.33A  
Lower roots

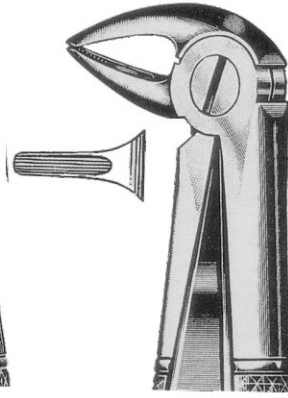

201-0024  
Fig.33C  
Lower roots

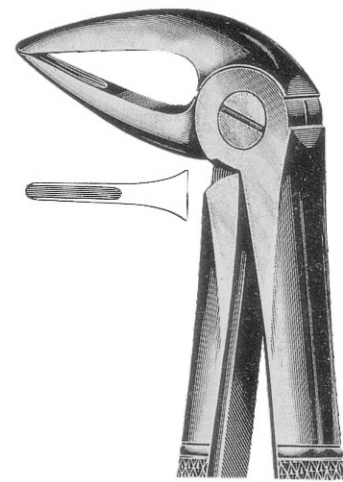

201-0025  
Fig.33M  
Lower roots with long beak

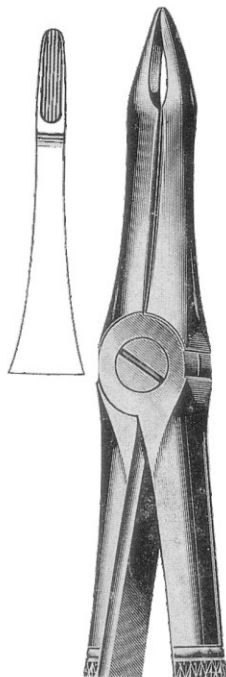

201-0026  
Fig.41  
Upper roots

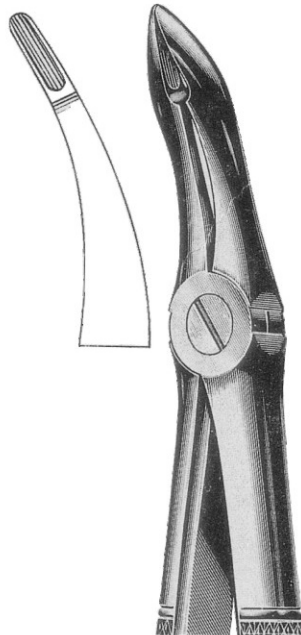

201-0027  
Fig.44  
Upper roots

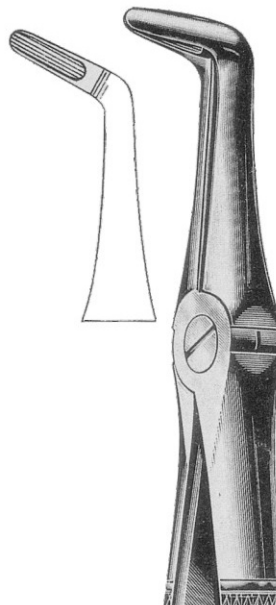

201-0028  
Fig.45  
Lower roots

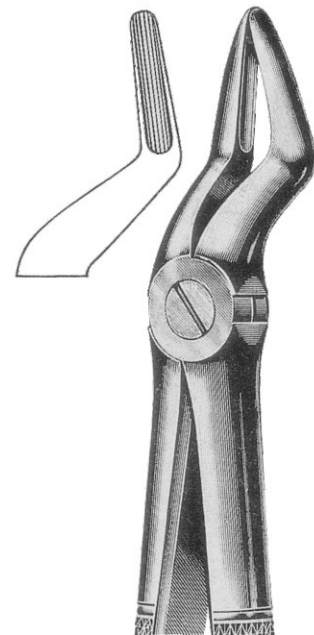

201-0029  
Fi g.51  
Upper roots

**EXTRACTING FORCEPS** ENGLISH PATTERN ●●●

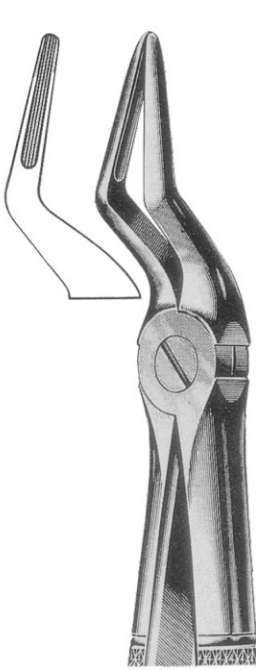

201-0030  
Fig.51A  
Upper roots narrow beak

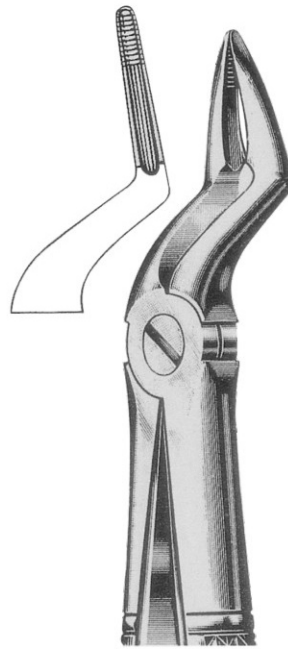

201-0031  
Fig.51C  
Upper roots

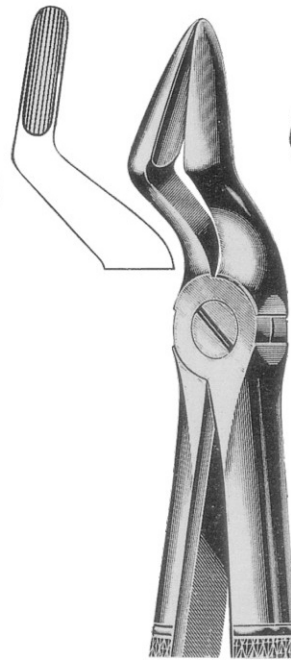

201-0032  
Fig.52  
Upper roots & canines  
with wider beak

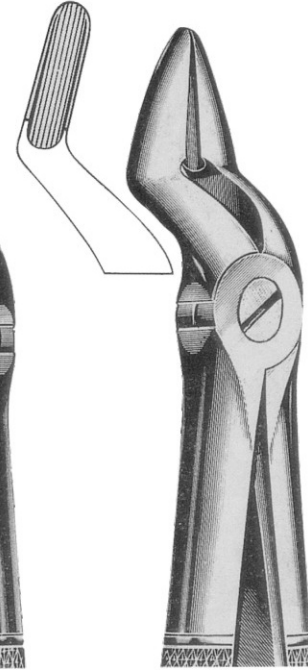

201-0033  
Fig.52A  
Upper teeth & resection

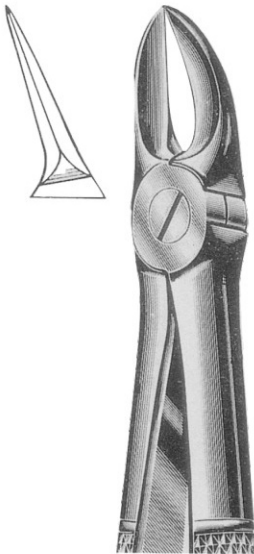

201-0034  
Fig.55  
Separating upper molars roots

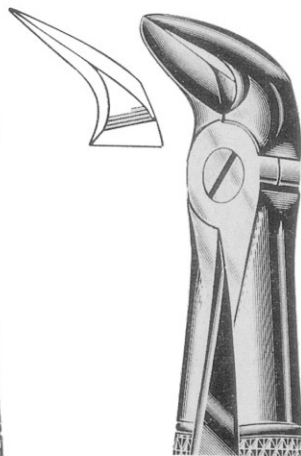

201-0035  
Fig.56  
Separating lower molars roots

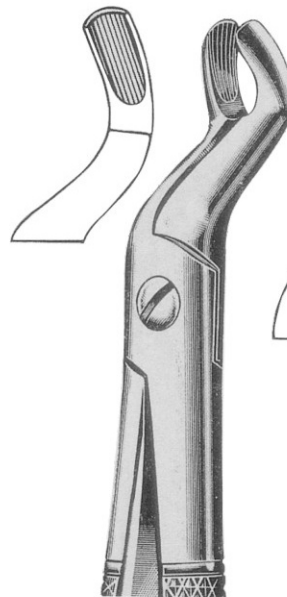

201-0036  
Fig.67  
Upper wisdoms

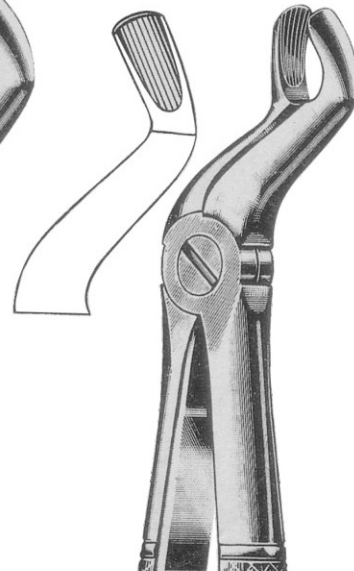

201-0037  
Fig.67A  
Upper wisdoms

●●● **EXTRACTING FORCEPS** ENGLISH PATTERN

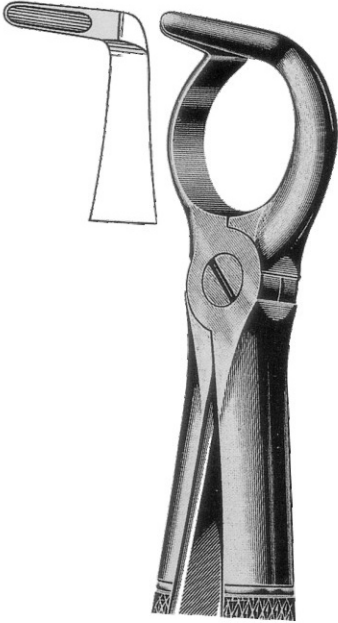

201-0038  
Fig. 68  
Lower roots

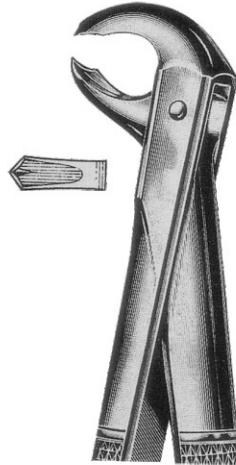

201-0039  
Fig. 73  
Lower molars (hawk's bill)

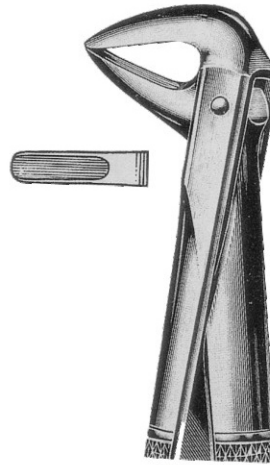

201-0040  
Fig. 74  
Lower incisors & roots

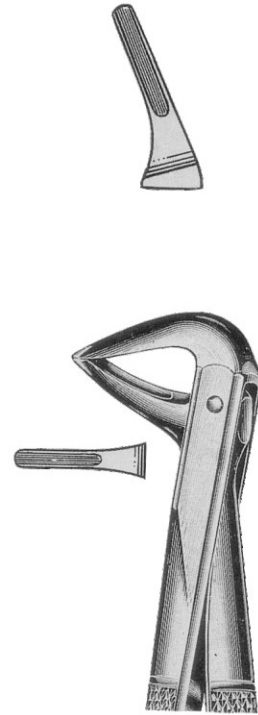

201-0041  
Fig. 74M  
Lower incisors & roots

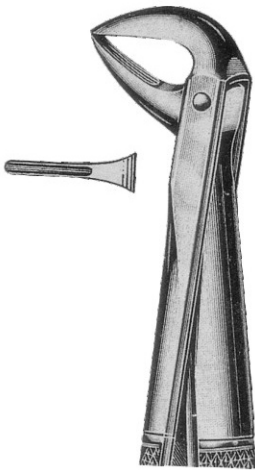

201-0042  
Fig. 74N  
Lower incisors & roots

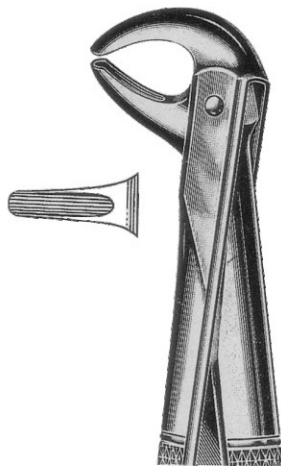

201-0043  
Fig. 75  
Lower premolars & canines

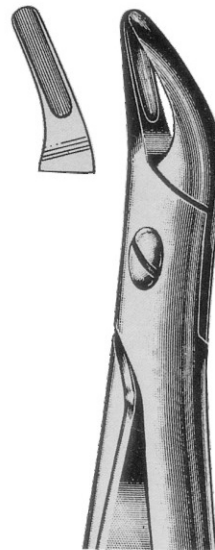

201-0044  
Fig. 76  
Upper roots

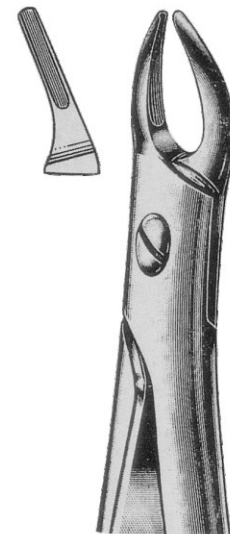

201-0045  
Fig. 76N  
Upper roots  
Narrow break



**EXTRACTING FORCEPS** ENGLISH PATTERN ●●●

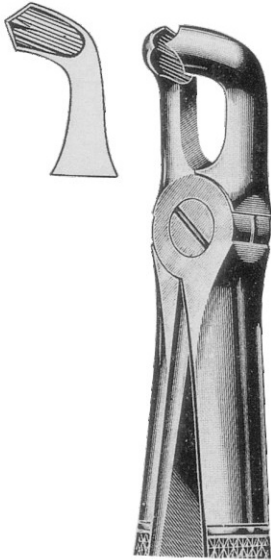

201-0046  
Fig.79  
Lower wisdoms

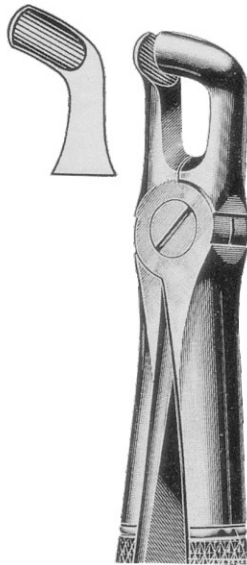

201-0047  
Fig.79A  
Lower wisdoms

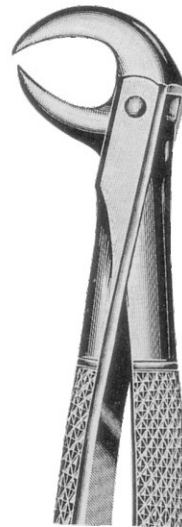

201-0048  
Fig.86A  
Lower molars



201-0049  
Fig. 86B  
Lower molars



201-0050  
Fig.86C  
Lower molars

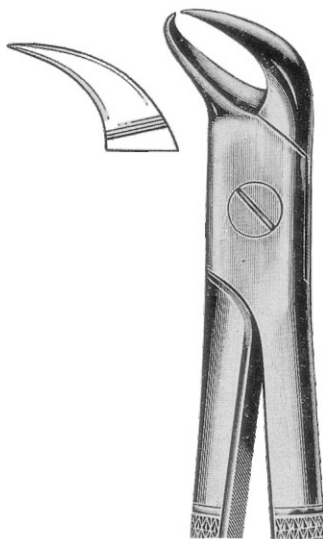

201-0051  
Fig.87  
Cowhorn beak

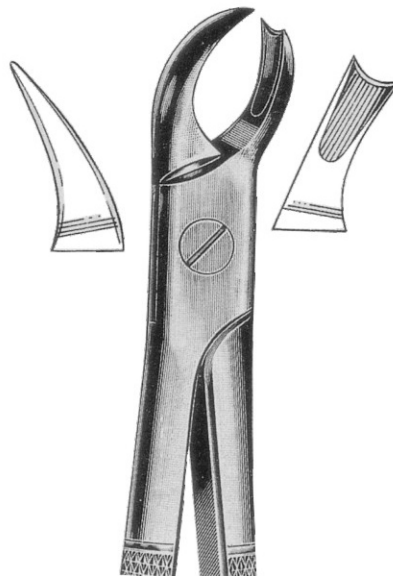

201-0052  
Fig.89  
Right upper molars



201-0053  
Fig.9  
Left upper molars

●●● **EXTRACTING FORCEPS** ENGLISH PATTERN

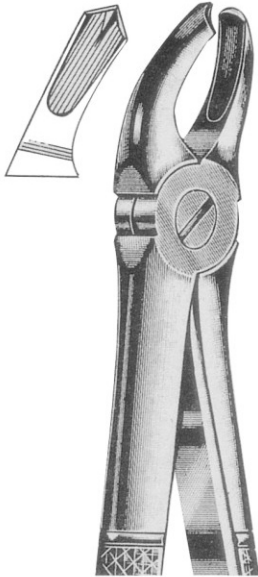

201-0054  
Fig.94  
Right upper molars

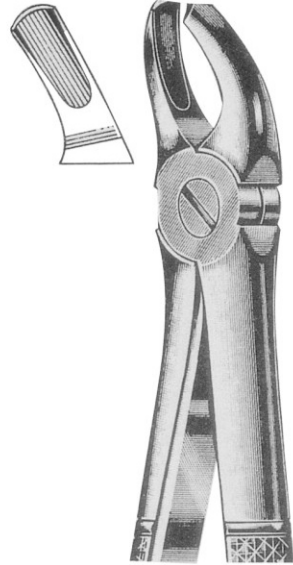

201-0055  
Fig.95  
Left upper molars

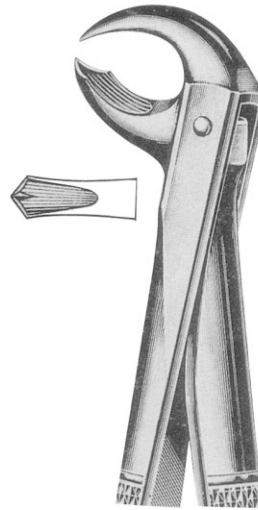

201-0056  
Fig.99  
Lower molars  
(broken-down)



201-0057  
Fig.99 1/4  
Lower molars  
(broken-down)

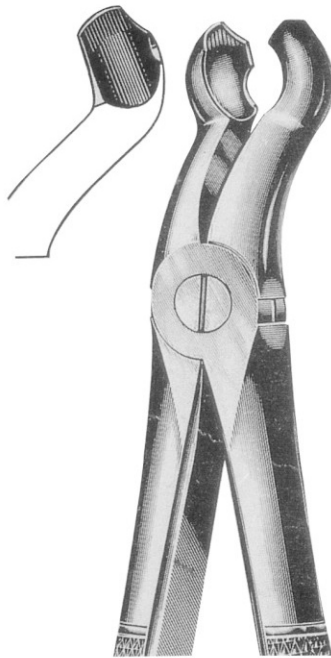

201-0058  
Fig.121  
Upper wisdoms

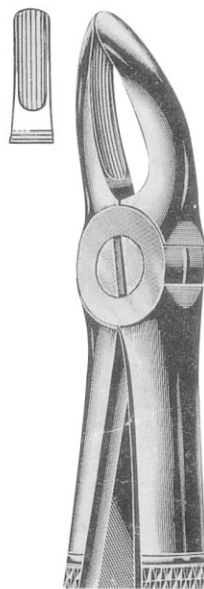

201-0059  
Fig.136  
Upper centrals  
& roots

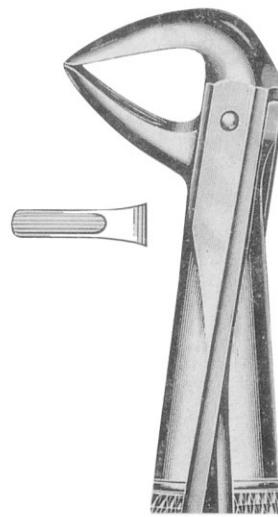

201-0060  
Fig.137  
Lower centrals  
& roots

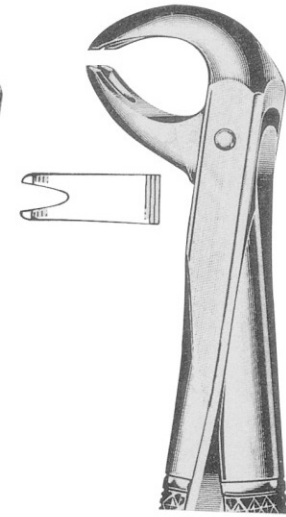

201-0061  
Fig.167  
Universal pincer  
for lower teeth  
molars & premolars

**EXTRACTING FORCEPS** ENGLISH PATTERN ●●●

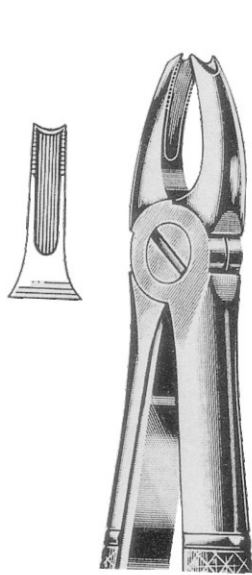

201-0062  
Fig.168  
Upper canines

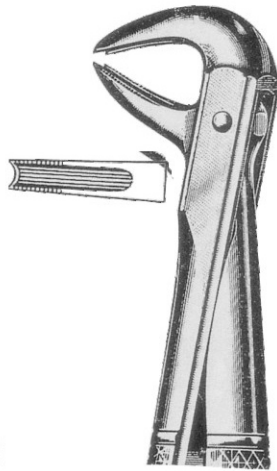

201-0063  
Fig.169  
Lower canines & premolars



201-0064  
Fig.233  
Lower roots (parallel beaks)

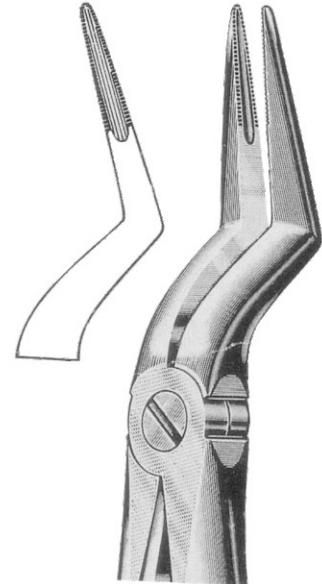

201-0065  
Fig.235  
Lower roots (parallel beaks)

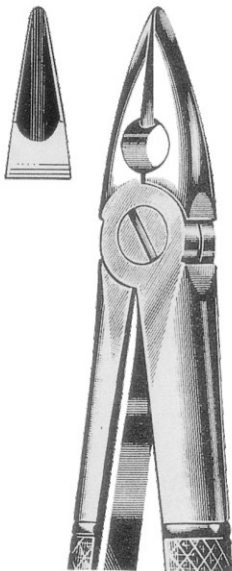

201-0066  
Fig.MD 1  
Universal Forceps for upper  
wisdoms, premolars & roots

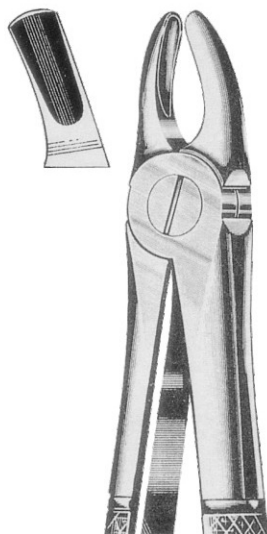

201-0067  
Fig.MD 2  
Upper molars

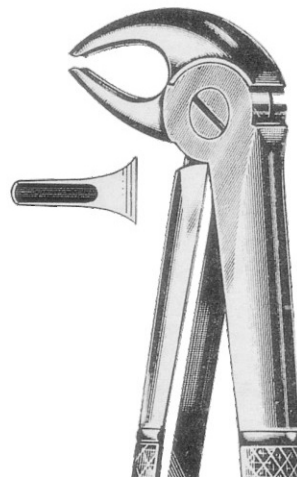

201-0068  
Fig.MD 3  
Lower incisors, premolars & roots

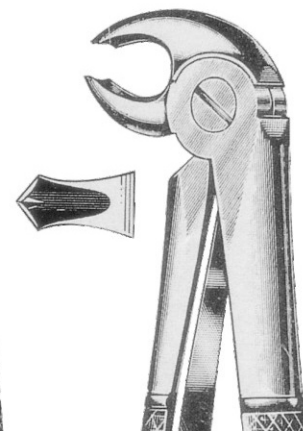

201-0069  
Fig.MD 4  
Lower molars



●●● **EXTRACTING FORCEPS** ENGLISH PATTERN

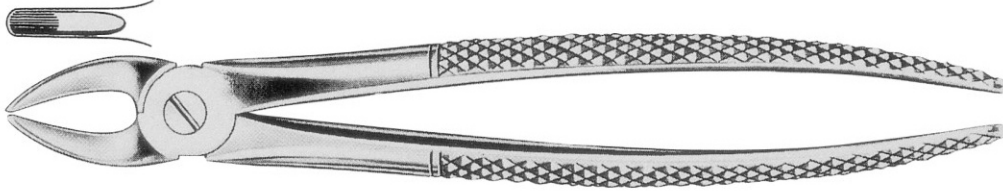

201-0070

Fig.37

Children's upper incisors & canines

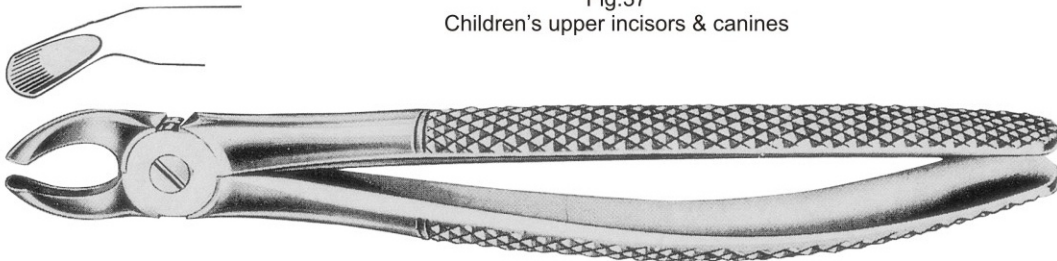

201-0071

Fig.39

Children's upper molars & universal

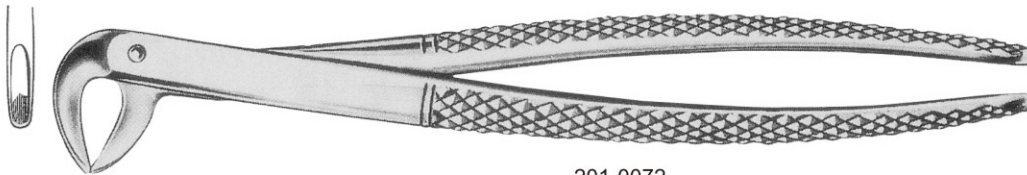

201-0072

Fig.123

Children's lower teeth universal

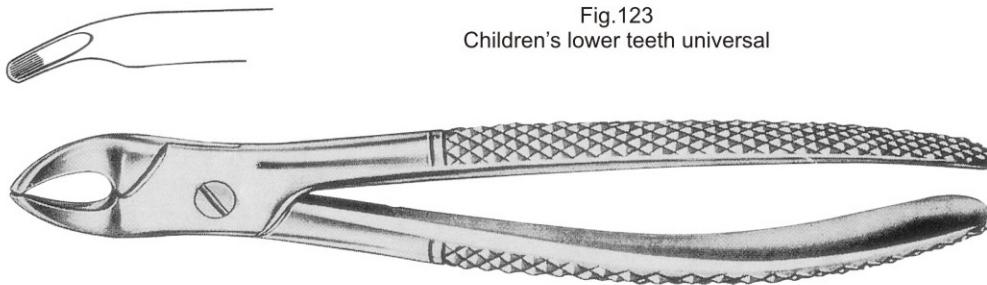

201-0073

Fig.138

Children's upper universal & roots

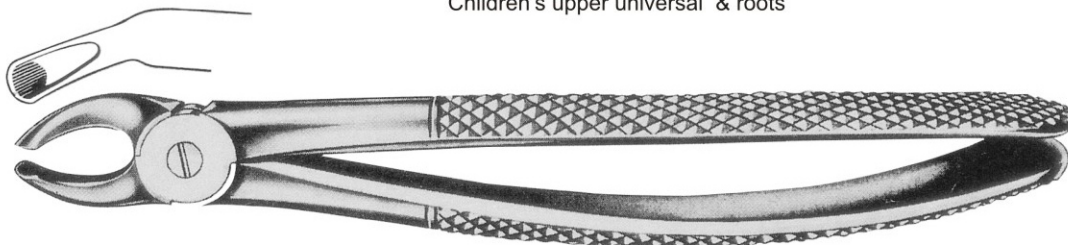

201-0074

Fig.157

Children's upper molars universal

**EXTRACTING FORCEPS** CHILDREN'S PATTERN ●●●

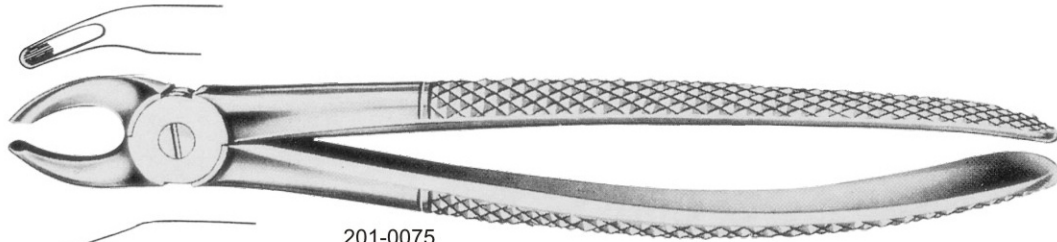

201-0075

Fig.158

Children's upper teeth molars universal

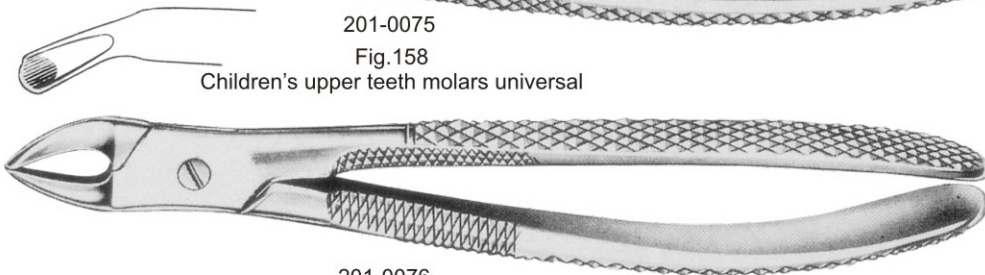

201-0076

Fig.159

Children's lower molars universal

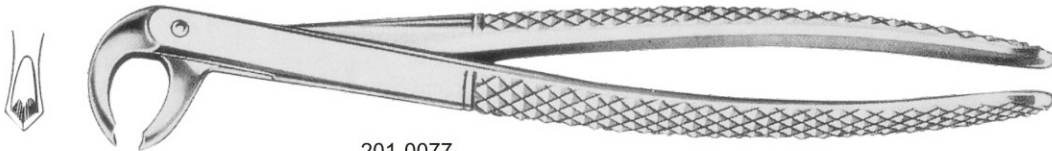

201-0077

Fig.160

Children's upper lower universal (hawk's bill)

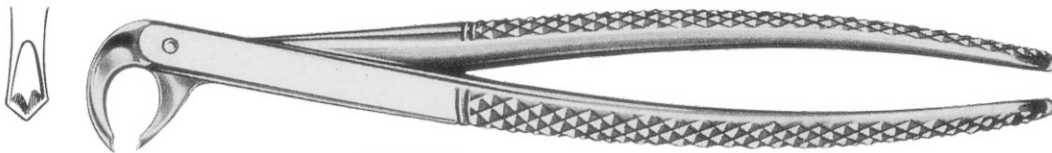

201-0078

Fig.161

Children's lower & roots

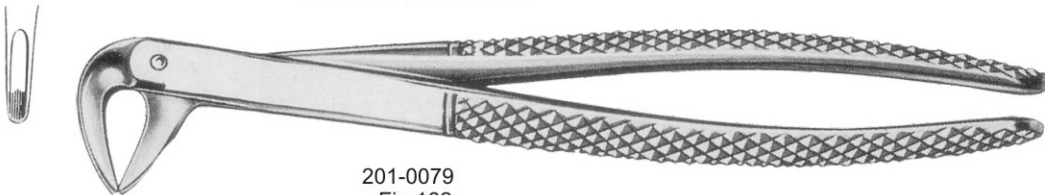

201-0079

Fig.162

Children's upper centrals

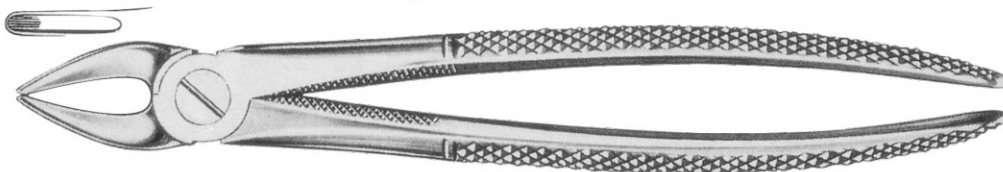

201-0080

Fig.163

Children's upper centrals

●●● **EXTRACTING FORCEPS** FOR CHILDREN'S WITH SPRING

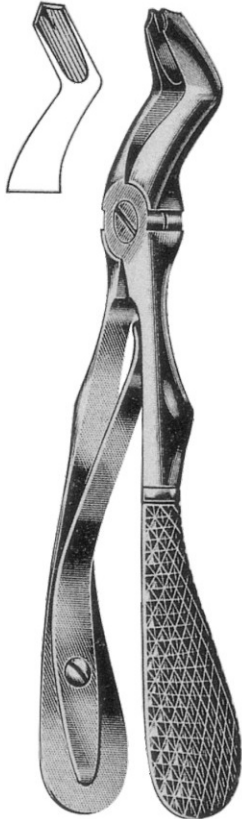

201-0081  
Fig. 3  
Upper molars

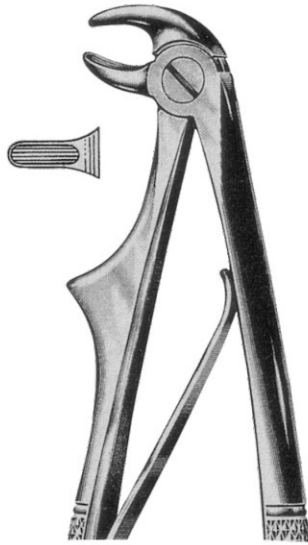

201-0082  
Fig. 5  
Lower incisors

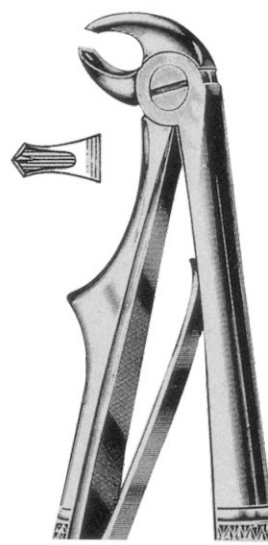

201-0083  
Fig. 6  
Lower molars

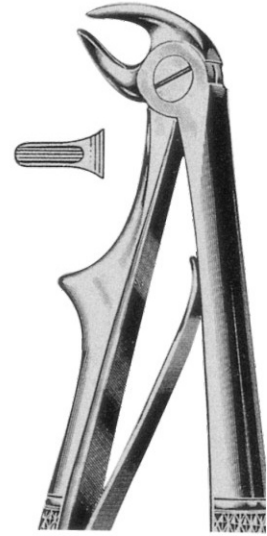

201-0084  
Fig. 7  
Lower roots



201-0085  
Fig. 137  
Upper incisors  
& canines

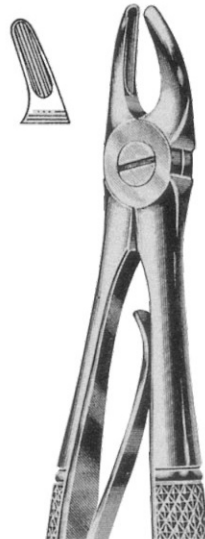

201-0086  
Fig. 139  
Upper premolars

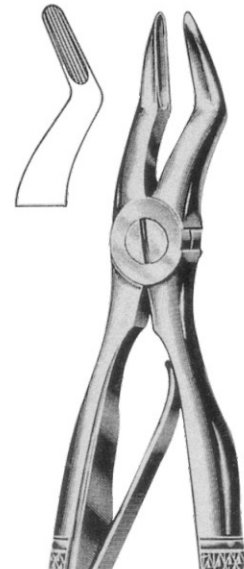

201-0087  
Fig. 51S  
Upper roots



**EXTRACTING FORCEPS** ROOT FRAGMENT FORCEPS ●●●

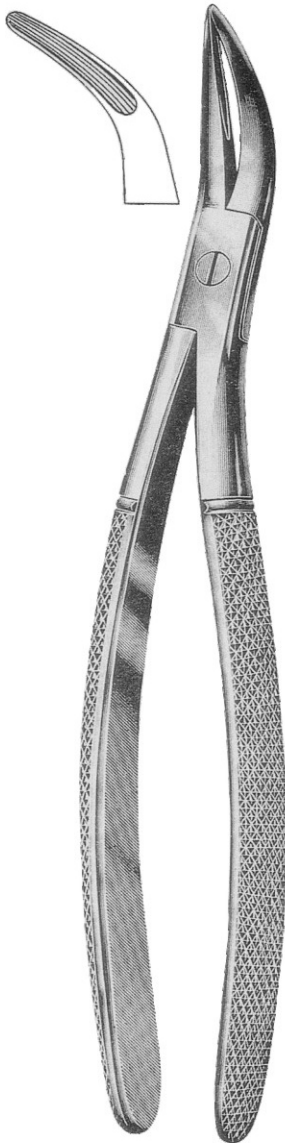

201-0088  
Universal pattern for upper teeth

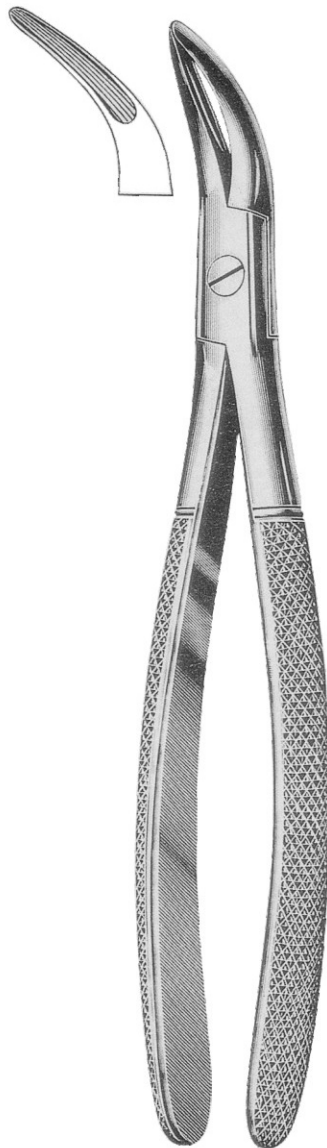

201-0089  
Universal pattern for lower teeth

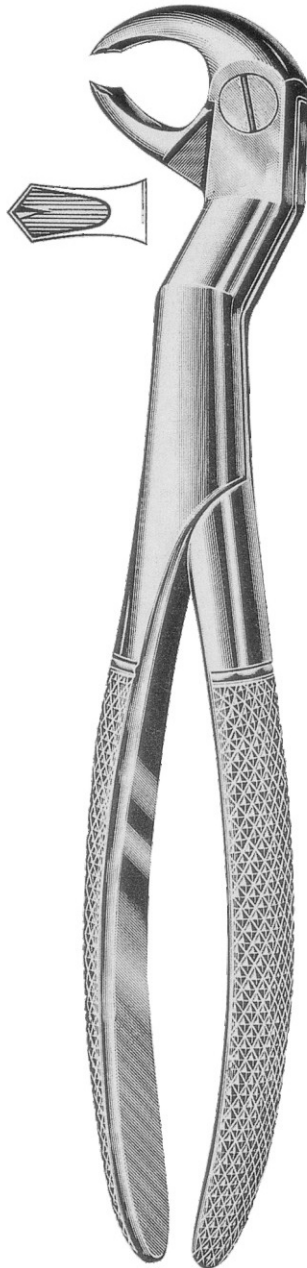

201-0090  
Fig. 22 1/2L  
Left lower wisdoms & molars

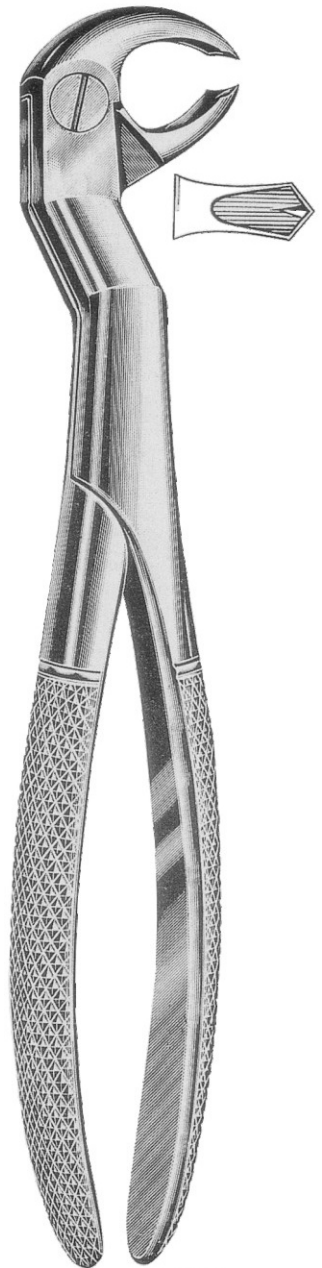

201-0091  
Fig. 22 1/2R  
Right lower wisdoms & molars

●●● **EXTRACTING FORCEPS** AMERICAN PATTERN

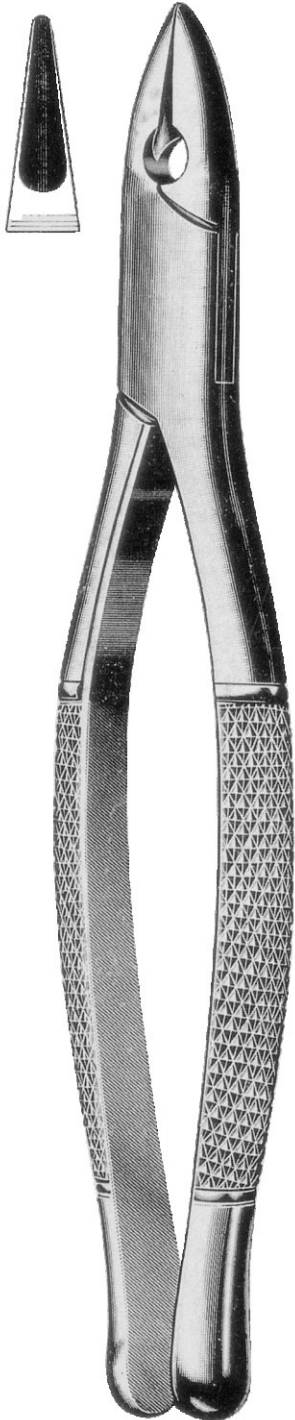

201-0092  
Fig. 1  
Upper centrals, laterals & cuspids

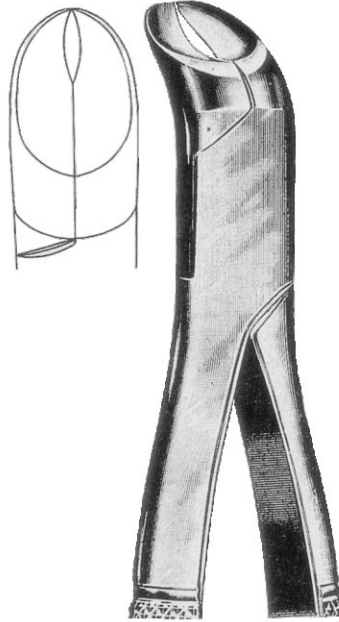

201-0093  
Fig. 5  
Lower third molars

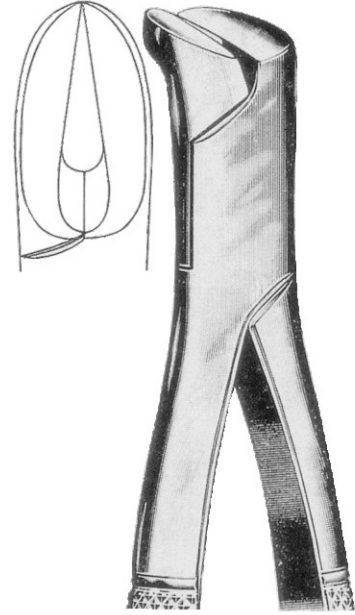

201-0094  
Fig. 6  
Splitting forceps

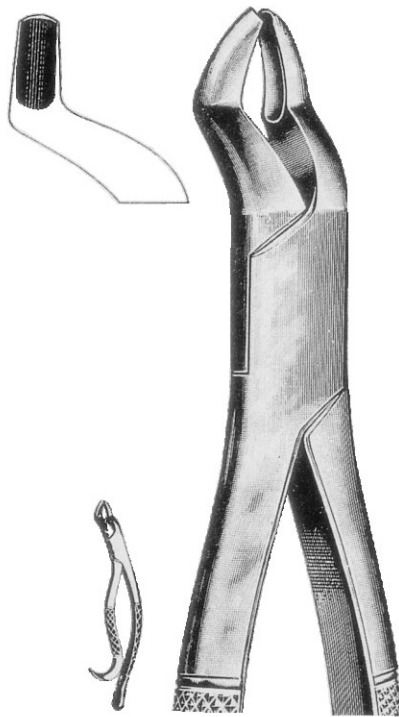

201-0095  
Fig. 10 H  
Upper molars hook-handle



201-0096  
Fig. 10 S  
Upper molars straight - handle



201-0097  
Fig. 15  
Lower molars



**EXTRACTING FORCEPS** AMERICAN PATTERN ●●●

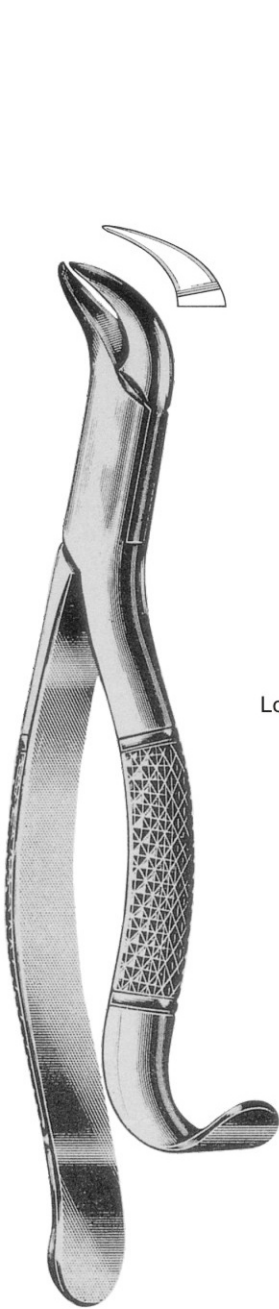

201-0098  
Fig. 16 S  
Lower molars children's



201-0099  
Fig. 16  
Lower molars (cow-horn beak)  
201-0100  
Fig.16 SK



201-0101  
Fig. 17  
Lower molars  
201-0102  
Fig.17 SK

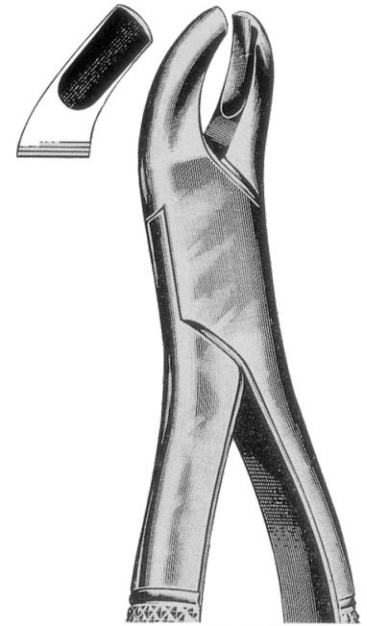

201-0103  
Fig. 18L  
Upper molars left side  
201-0104  
Fig.18L SK

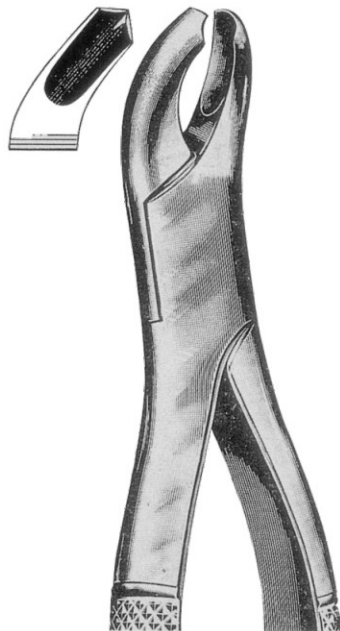

201-0105  
Fig. 18R  
Upper molars right side  
201-0106  
Fig.18R SK

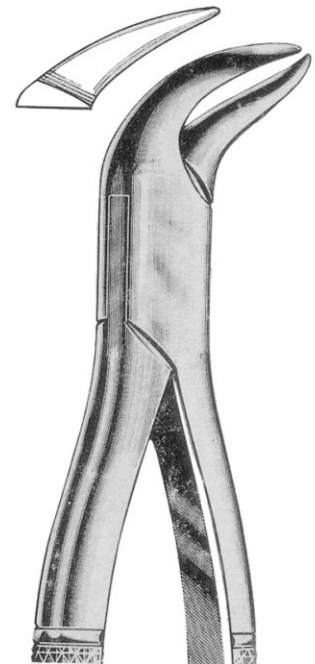

201-0107  
Fig. 23  
Lower molars (cow-horn beak)  
201-0108  
Fig.23 SK



●●● **EXTRACTING FORCEPS** AMERICAN PATTERN

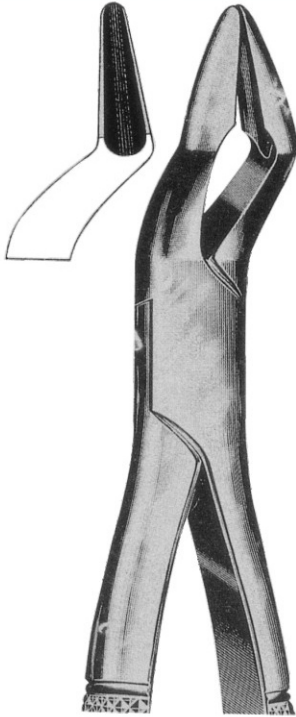

201-0109  
Fig. 32  
Upper molars & pre molars  
strong beak  
201-0110  
Fig. 32 SK

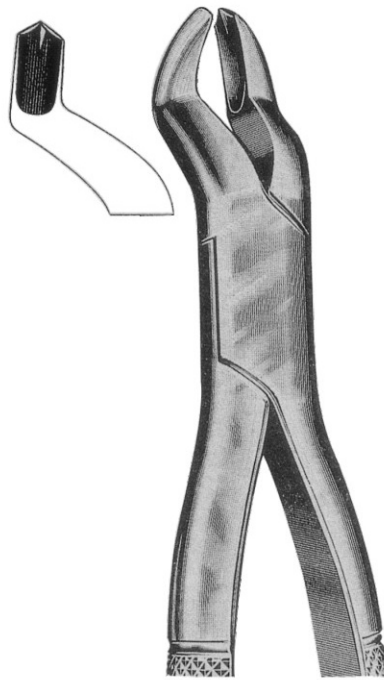

201-0111  
Fig. 53 L  
Upper molars left side  
201-0112  
Fig. 53 L SK

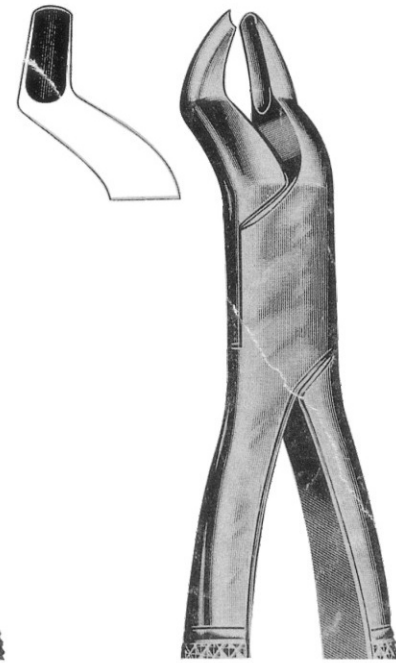

201-0113  
Fig. 53 R  
Upper molars right side  
201-0114  
Fig. 53R SK

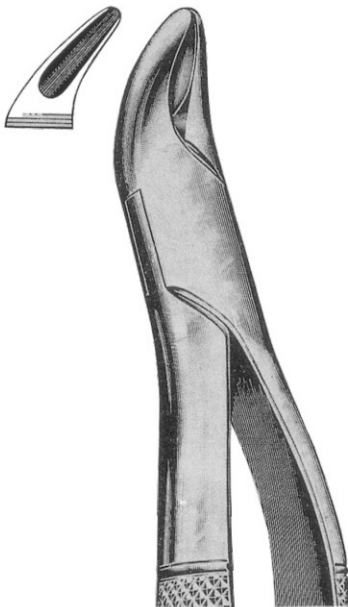

201-0115  
Fig. 62  
Universal forceps  
for upper teeth & roots  
201-0116  
Fig. 62 SK

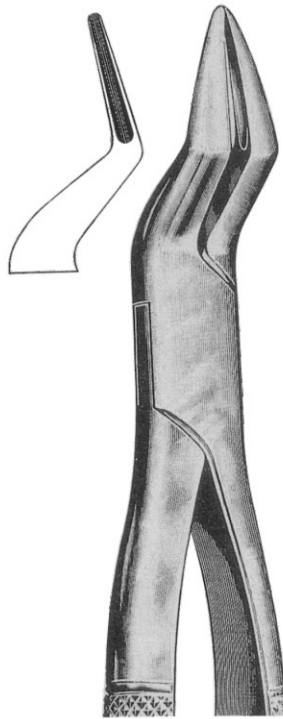

201-0117  
Fig. 65  
Upper Incisors & root  
201-0118  
Fig. 65 SK

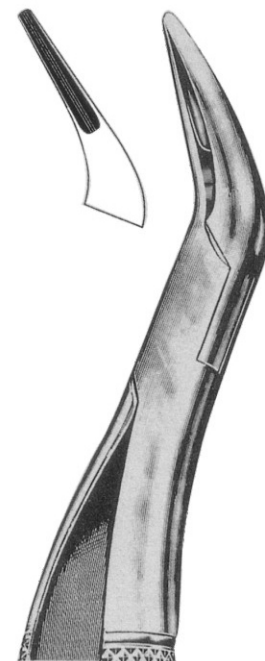

201-0119  
Fig. 69  
Fragments & small roots  
Upper & lower  
201-0120  
Fig. 69 SK

**EXTRACTING FORCEPS** AMERICAN PATTERN ●●●

AMERICAN PATTERN

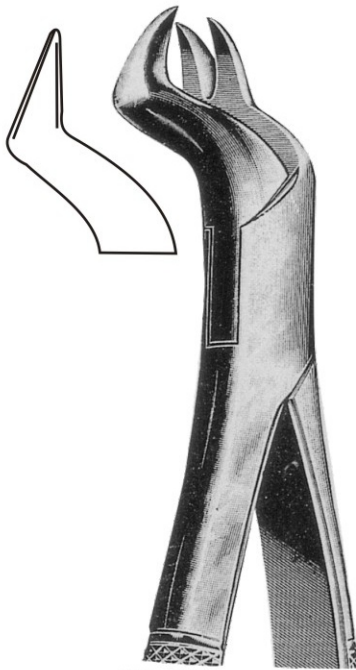

201-0121  
Fig. 88 R  
Right upper molars  
201-0122  
Fig. 88 R SK

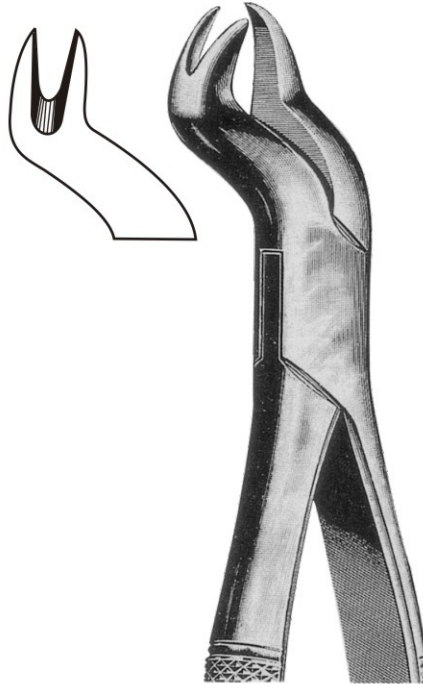

201-0123  
Fig. 88L  
Left upper molars  
201-0124  
Fig. 88L SK

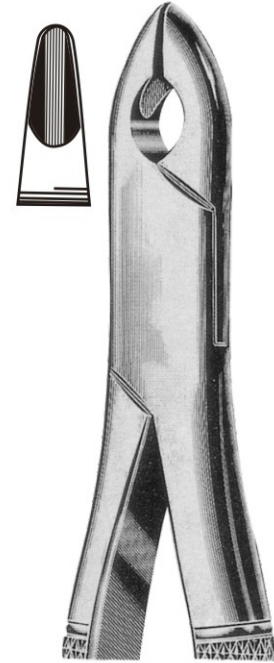

201-0125  
Fig. 99C  
Upper Premolars,  
Molar & incisors  
201-0126  
Fig. 99C SK

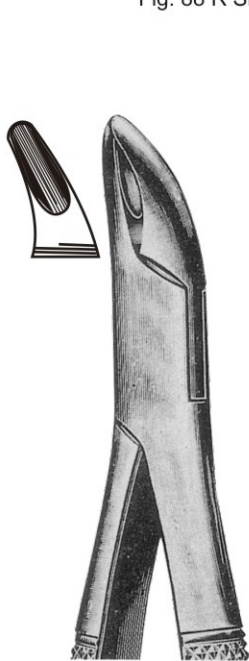

201-0127  
Fig. 101  
Universal forceps  
for premolars  
201-0128  
Fig. 101 SK

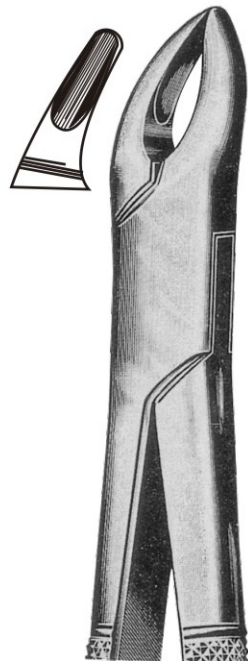

201-0129  
Fig. 150  
Upper premolars,  
incisors & roots  
201-0130  
Fig. 150 SK

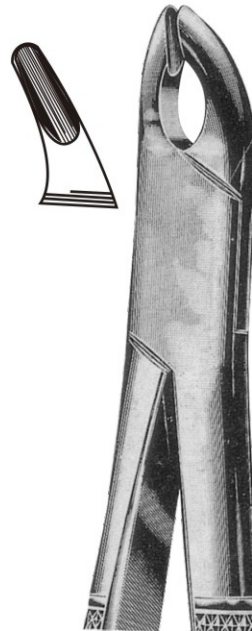

201-0131  
Fig. 150A  
Upper premolars incisors & roots  
201-0132  
Fig. 150A SK

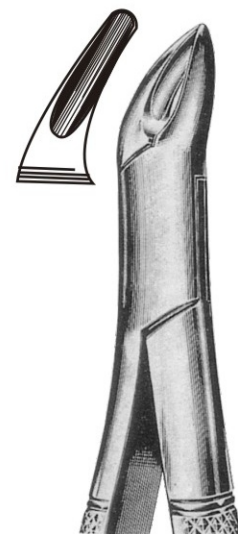

201-0133  
Fig. 150S  
Upper premolars incisors & roots  
for children  
201-0134  
Fig. 150 SK



●●● **EXTRACTING FORCEPS** AMERICAN PATTERN

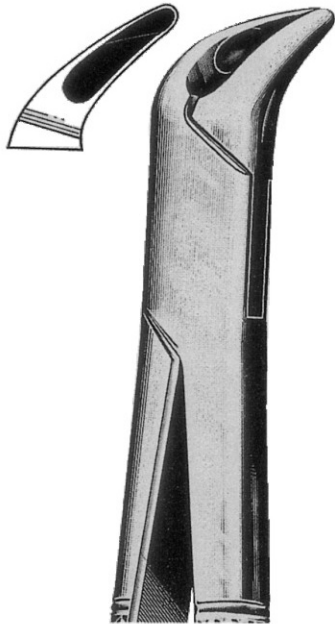

201-0135  
Fig. 151  
Lower premolars, incisors & roots  
201-0136  
Fig. 151 SK

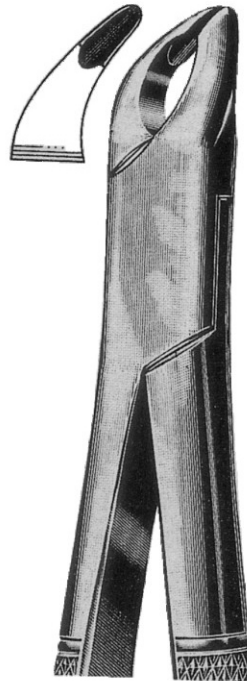

201-0137  
Fig. 151A  
Lower premolars, incisors & roots  
201-0138  
Fig. 151A SK

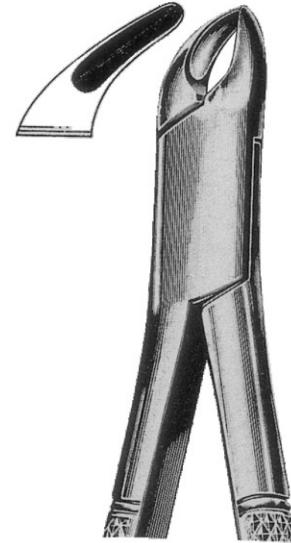

201-0139  
Fig. 151S  
Lower premolars, incisors & roots  
for children's  
201-0140  
Fig. 151 SK

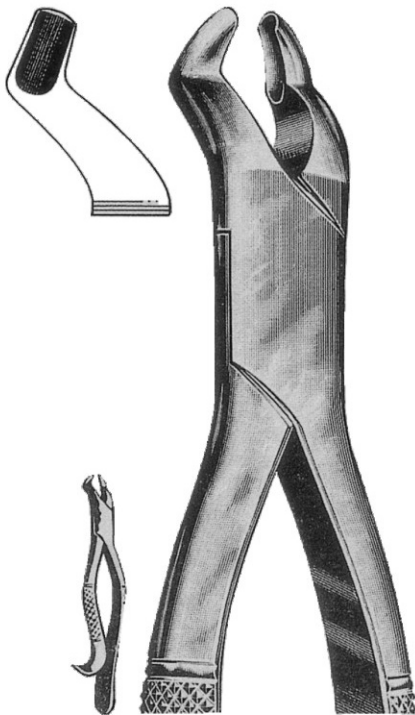

201-0141  
Fig. 210H  
Upper wisdoms with  
hook handle  
201-0142  
Fig. 210H SK

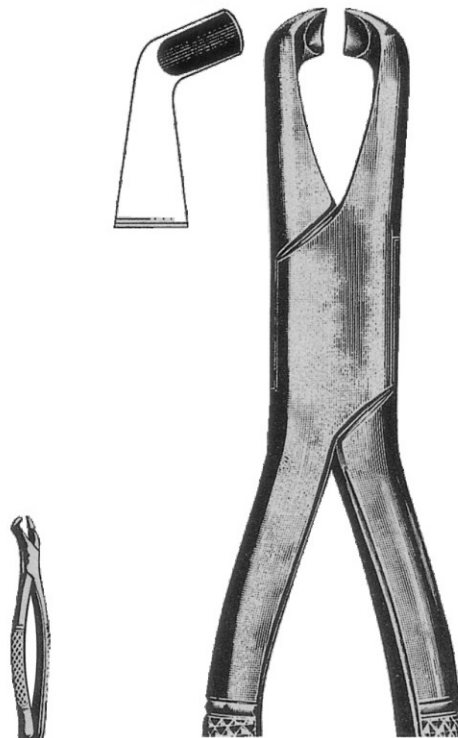

201-0143  
Fig. 210S  
Upper wisdoms with  
straight handle  
201-0144  
Fig. 210 SK

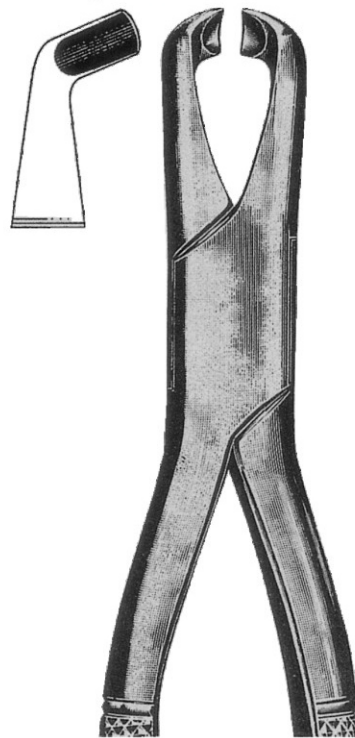

201-0145  
Fig. 222  
Lower wisdoms  
201-0146  
Fig. 222 SK

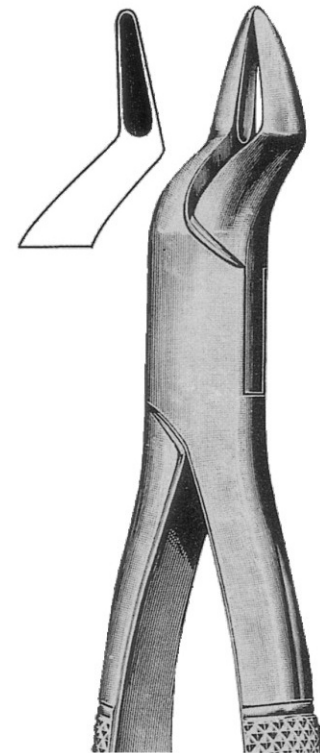

201-0147  
Fig. 286  
Upper roots, premolars & incisors  
20-0148  
Fig. 286 SK



**EXTRACTING FORCEPS** EXTRACTION TWEEZER ●●●

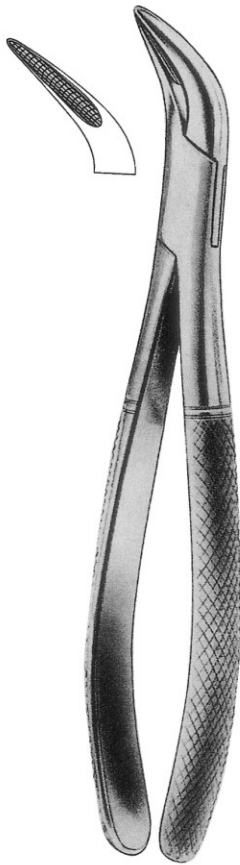

201-0149  
Fig. 1  
Lower roots

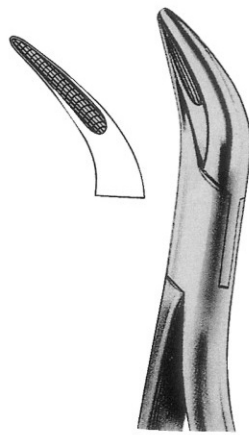

201-0150  
Fig. 2  
Upper roots



201-0151  
Fig. 44  
201-0152  
Fig. 44 SK



201-0153  
Albrecht 16cm

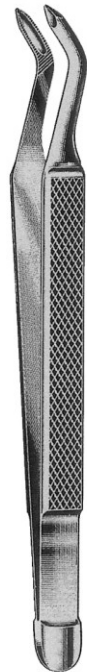

201-0154  
Albrecht 16cm

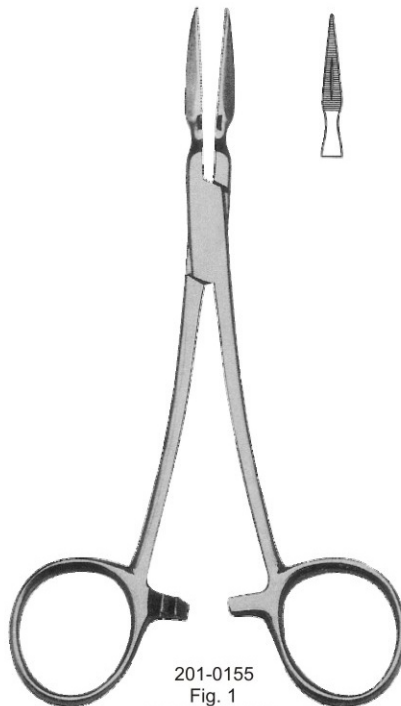

201-0155  
Fig. 1  
Root fragments



201-0156  
Fig. 2  
Root fragments

●●● PLIERS FOR ORTHODONTICS & PROSTHETICS



202-0001  
Waldsachs  
15cm



202-0002  
Universal  
16cm



202-0003  
Nance  
13.5



202-0004  
Aderer  
14.5cm



202-0005  
Model marburg  
Serrated jaws  
14cm

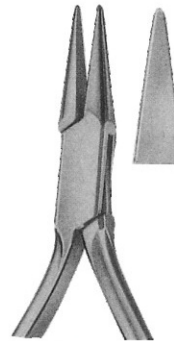

202-0006  
Model marburg  
Smooth jaws  
14cm

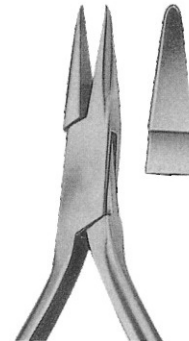

202-0007  
Model marburg  
Carbid inserts jaws  
14cm

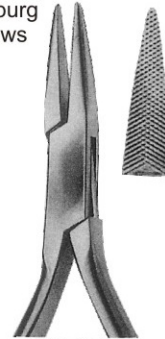

202-0008  
Goslee  
One Serrated jaws  
14cm

**PLIERS FOR ORTHODONTICS & PROSTHETICS ●●●**

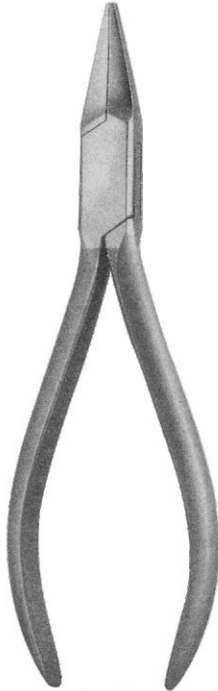

202-0009  
Flat Pliers  
14cm



202-0010  
14cm



202-0011  
14cm



202-0012  
14.5cm



202-0013  
14.5cm



202-0014  
14cm



202-0015  
14cm



202-0016  
14cm



202-0017  
Serrated jaws  
12cm

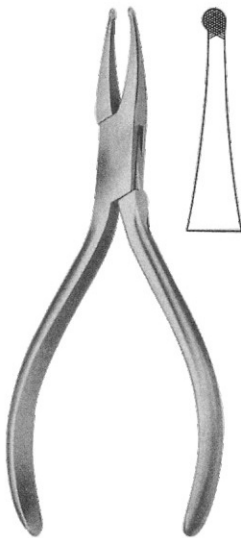

202-0018  
How  
14.5cm

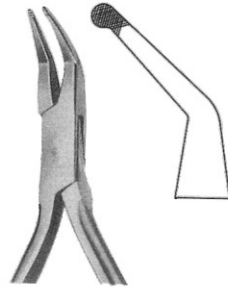

202-0019  
How-angled  
14.5cm



202-0020  
Arrow clasp forming  
12cm

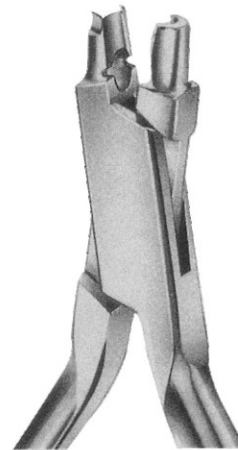

202-0021  
Arrow clasp forming  
12cm

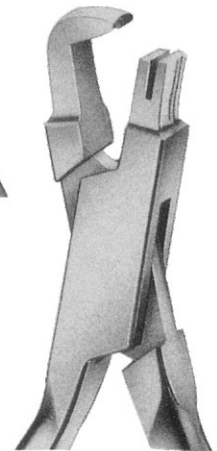

202-0022  
Arrow clasp bending  
12cm



●●● PLIERS FOR ORTHODONTICS & PROSTHETICS



202-0023  
Peeso  
13.5cm

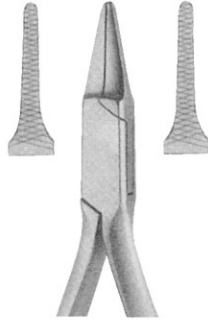

202-0024  
Peeso  
13.5cm



202-0025  
14cm

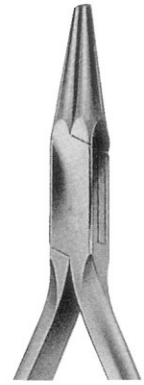

202-0026  
Langenbeck  
14cm

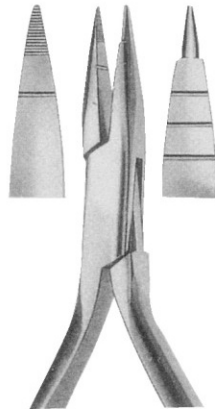

202-0027  
Jarabak  
14cm

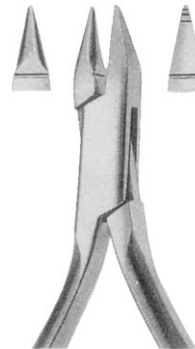

202-0028  
Bending Plier  
13cm

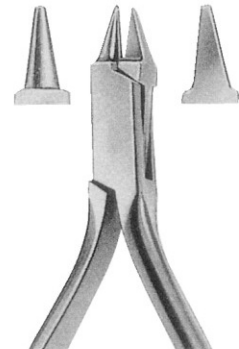

202-0029  
Angle  
12.5cm



202-0030  
Andresen  
13cm

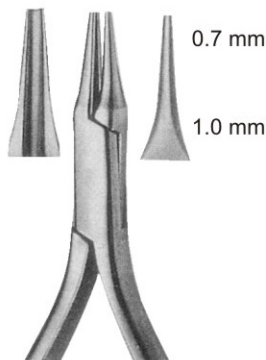

202-0031  
Bending Plier  
13.5cm

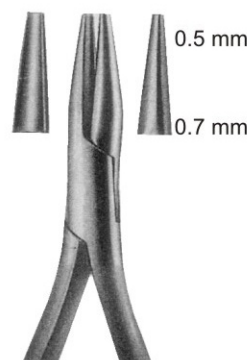

202-0032  
Schwarz  
13.5cm

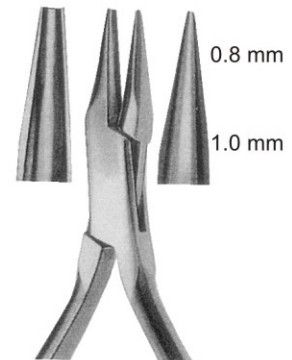

202-0033  
Fischer  
13cm

**PLIERS FOR ORTHODONTICS & PROSTHETICS ●●●**

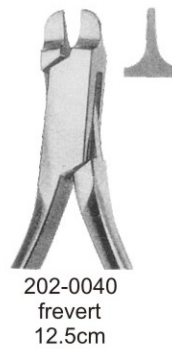
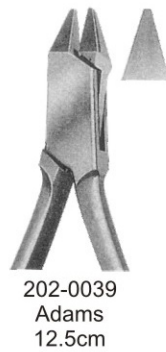
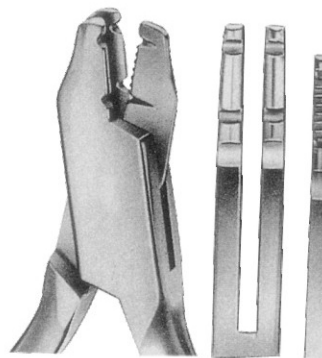
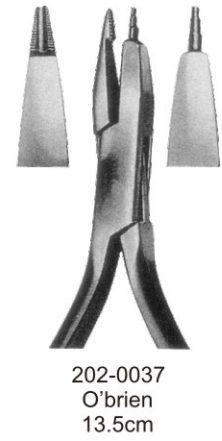
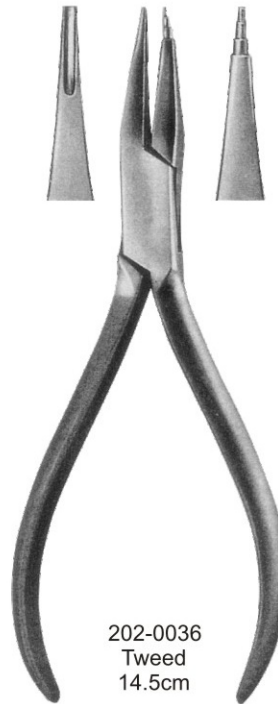

●●● **PLIERS FOR ORTHODONTICS & PROSTHETICS**



202-0043  
Hard Wire Cutter  
5 1/2" (14 cm)



202-0044  
Arch Forming Plier  
5 1/2" (14 cm)



202-0045  
Medium Size Bending Pliers  
5 1/2" (14 cm)



202-0046  
Aderer Pliers  
5 1/2" (14 cm)



202-0047  
Wire Bending Plier  
5 1/2" (14 cm)



202-0048  
Round & Concave Plier  
5 1/2" (14 cm)



202-0049  
Aderer Pliers  
with narrow standing points,  
for bending wires up to  $\varnothing$  0.5mm,  
disinfectable, sterilizable  
4 3/4" (12cm)



202-0050  
Aderer Pliers  
for bending wires up to  $\varnothing$  0.9mm,  
disinfectable, sterilizable  
4 3/4" (12cm)



202-0051  
Bending plier for lingual cleat  
5 1/2" (14cm)



**PLIERS FOR ORTHODONTICS & PROSTHETICS ●●●**



**202-0052**  
Bracket Removing Pliers  
5 ½" (14 cm)



**202-0053**  
Bracket Removing Pliers  
5 ½" (14 cm)



**202-0054**  
Bracket Removing Pliers  
5 ½" (14 cm)



**202-0055**  
Bracket Removing Pliers  
5 ½" (14cm)



**202-0056**  
Bracket Removing Pliers  
5 ½" (14cm)



**202-0057**  
Flat Pliers  
5 ½" (14 cm)



**202-0058**  
Nance Closing Loop Pliers  
5 ½" (14 cm)



**202-0059**  
Angle Bending Pliers  
5 ½" (14 cm)



**202-0060**  
Crown Crimping Pliers  
5 ½" (14 cm)

●●● **PLIERS FOR ORTHODONTICS & PROSTHETICS**



202-0061  
Round & Flat Plier  
5 1/2" (14 cm)



202-0062  
Tweed Angle Arch Bending  
5 1/2" (14 cm)



202-0063  
Band Removing Pliers  
5 1/2" (14 cm)



202-0064  
Johnson Contouring Pliers  
5 1/2" (14 cm)



202-0065  
Round Nose Pliers  
5 1/2" (14 cm)



202-0066  
Tweed Angle Arch Bending  
5 1/2" (14 cm)



202-0067  
De La Rosa Pliers  
5 1/2" (14 cm)



202-0068  
Arch Forming Plier  
5 1/2" (14 cm)



202-0069  
Tweed Angle Arch Bending  
5 1/2" (14 cm)

**PLIERS FOR ORTHODONTICS & PROSTHETICS ●●●**



202-0070  
Flat Nose Plier  
5 ½" (14 cm)



202-0071  
How Pliers  
5 ½" (14 cm)



202-0072  
Gordon - Contouring  
5 ½" (14 cm)



202-0073  
Adams Pliers  
5 ½" (14 cm)



202-0074  
Adams Pliers  
5 ½" (14 cm)



202-0075  
Tweed Pliers  
5 ½" (14 cm)



202-0076  
Bending Pliers  
mediumfine, with graduation,  
for wires upø 1.0mm  
5 ½" (14cm)



202-0077  
Special pliers  
max .022" x .028"  
5 ½" (14cm)

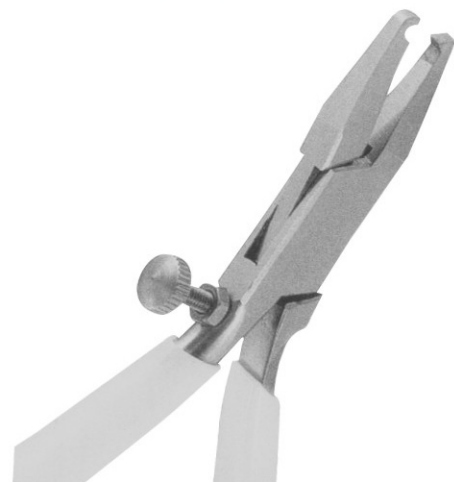

202-0078  
Pliers for operating the Mobil-Stop  
5 ½" (14cm)



●●● **PLIERS FOR ORTHODONTICS & PROSTHETICS**



202-0079  
Light wire pliers for wires  
up to  $\varnothing$  0.60mm  
with cutter Begg  
4¾" (12cm)



202-0080  
Weingart Universal Pliers  
5 ½" (14 cm)



202-0081  
Weingart ultra lightwire Pliers  
5 ½" (14 cm)



202-0082  
Weingart Universal lightwire Pliers  
max .022" x .028  
5 ½" (14cm)



202-0083  
Universal Facebow Pliers  
6 ½" (16.5cm)

**CARBIDE INSERTED PLIERS ●●●**



202-0084  
Distel Cutter Light Weight  
5 ½" (14 cm)



202-0085  
Distel Cutter medium  
5 ½" (14 cm)



202-0086  
Ligature Pin Cutter  
5 ½" (14 cm)



201-0087  
Hard Wire Cutter  
5 ½" (14 cm)



202-0088  
Hard Wire Cutter  
5 ½" (14 cm)



202-0089  
Bracket Removing Pliers  
5 ½" (14 cm)

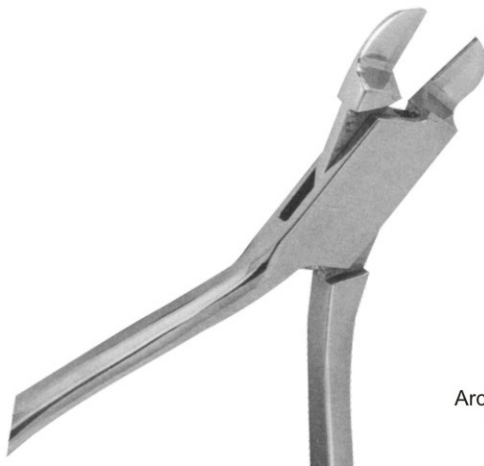

202-0090  
Arch torquing and bending pliers  
for wires up to ø 0.60mm  
allow to user a pair  
4¾" (12cm)

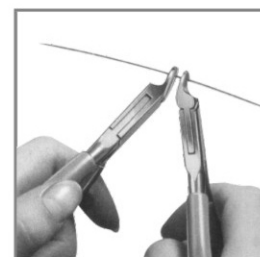

●●● **BONE RONGEURS**



203-0001  
BEYER  
150mm (6")  
5mm bite

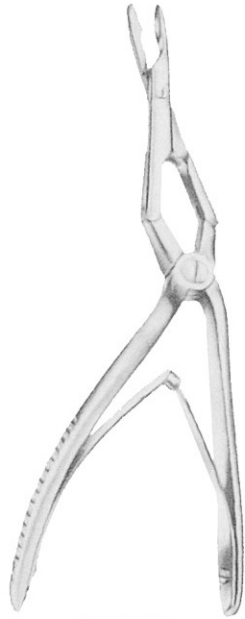

203-0002  
JANSEN-MIDDLETON  
SEPTUM FORCEPS  
200mm (8") Spoon shaped  
4mm bite

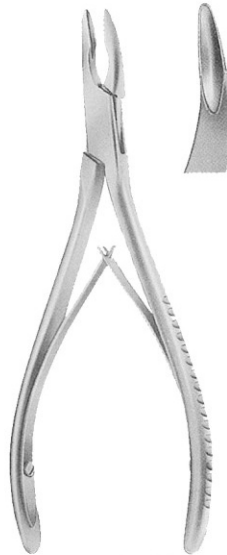

203-0003  
CAIRNS  
140mm (5.1/2")  
4mm bite



203-0004  
CAIRNS  
140mm (5.1/2")  
4mm bite

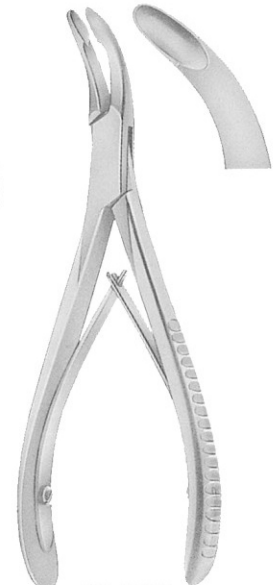

203-0005  
LUER  
155mm (6")

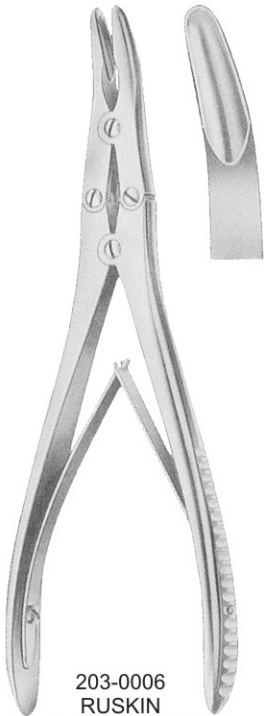

203-0006  
RUSKIN  
190mm (7.1/2")  
6mm bite

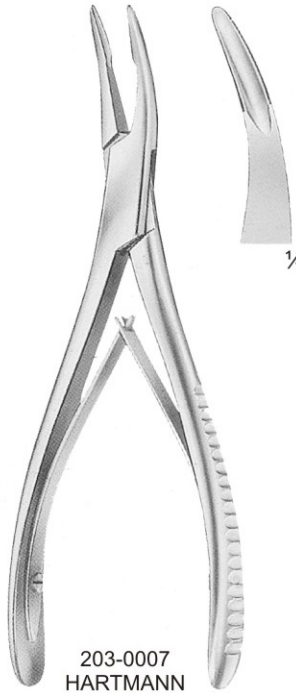

203-0007  
HARTMANN  
180mm (7")

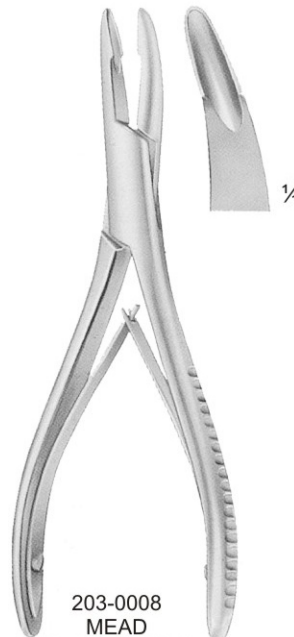

203-0008  
MEAD  
165mm (6.1/2")



203-0009  
JANSEN  
150mm (6")



**BONE RONGEURS ●●●**



203-0010  
TROTTER  
200mm (8")  
10mm bite

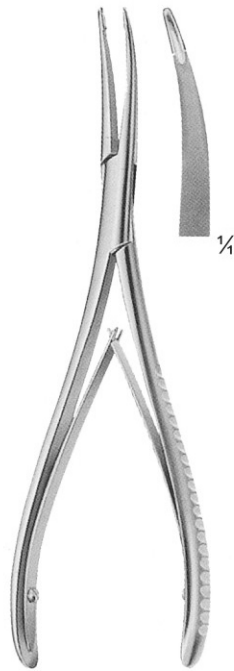

203-0011  
SYNOVECTOMY  
RONGEUR  
175mm (7")



203-0012  
HEANLEY  
175mm (7")  
4mm bite



203-0013  
PENNYBACKER  
200mm (8")  
4mm bite

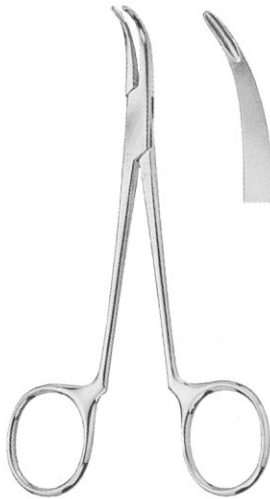

203-0014  
SYNOVECTOMY  
RONGEUR  
130mm (5.1/8")  
Jaw width 2mm



203-0015  
NORTHFIELD  
200mm (8")  
10mm bite



203-0016  
WILMS  
200mm (8")  
4mm bite

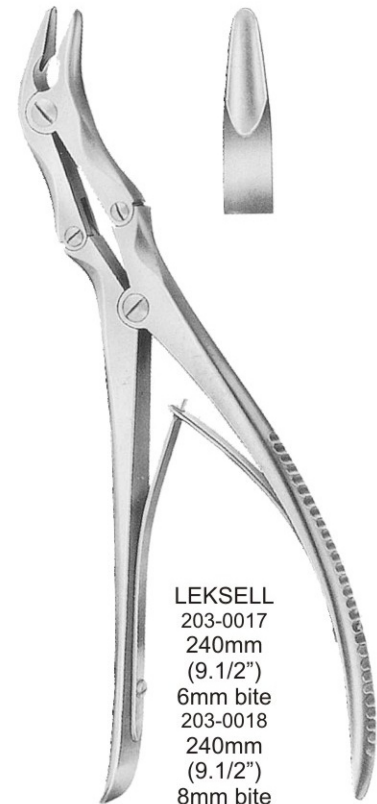

LEKSELL  
203-0017  
240mm  
(9.1/2")  
6mm bite  
203-0018  
240mm  
(9.1/2")  
8mm bite

●●● **BONE RONGEURS**

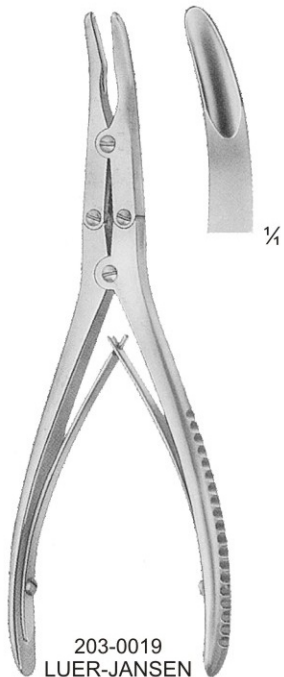

203-0019  
LUER-JANSEN  
170mm (6.3/4")  
4mm bite

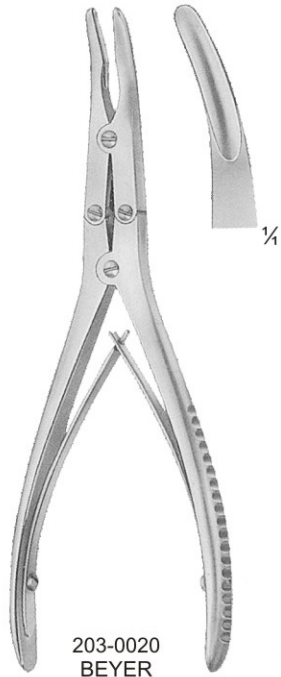

203-0020  
BEYER  
180mm (7")



203-0021  
BEYER  
200mm (8")



203-0022  
KILLEARN  
197mm (7.3/4")  
3mm bite



203-0023  
ZAUFGAL-JANSEN  
240mm (9.1/2")



203-0024  
ECHLIN  
240mm (9.1/2")

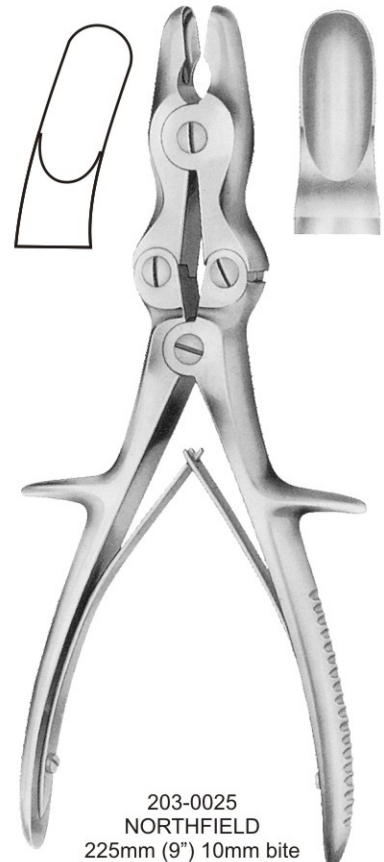

203-0025  
NORTHFIELD  
225mm (9") 10mm bite

**BONE RONGEURS ●●●**



203-0026  
SARGENT (VAN HAVRE)  
220mm (8.3/4")  
10mm bite



203-0027  
OLIVECRONA  
230mm (9")  
6mm bite



203-0028  
STILLE-RUSKIN  
240mm (9.1/2")

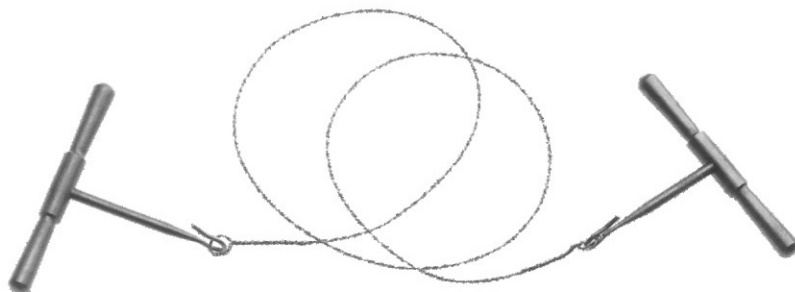

203-0029  
GIGLI SAW WITH HANDLE  
500mm (20")

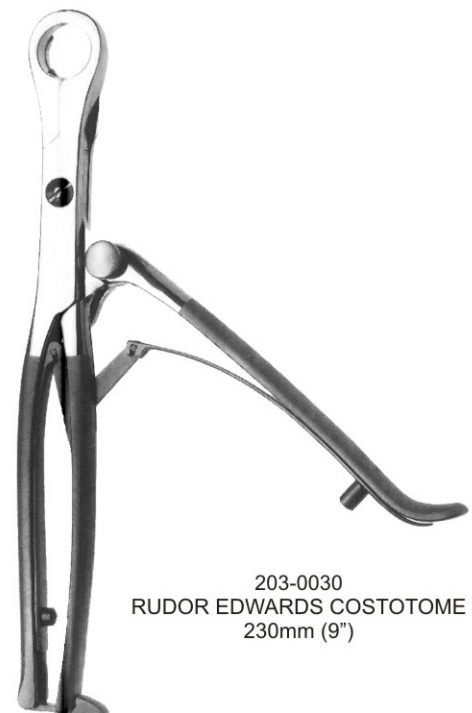

203-0030  
RUDOR EDWARDS COSTOTOME  
230mm (9")



●●● ROOT ELEVATORS

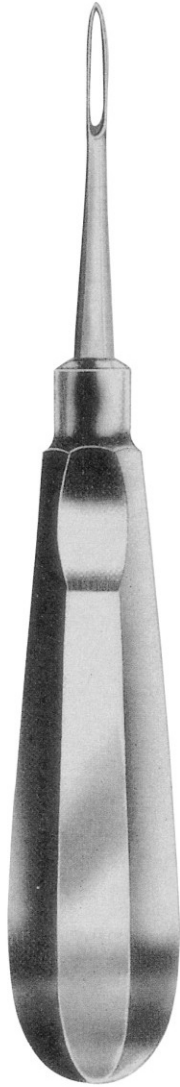

204-0001  
Fig. 1B  
Bein



204-0002  
Fig. 2B  
Bein



204-0003  
Fig. 3B  
Bein



204-0004  
Fig. 4B  
Bein



204-0005  
Fig. 5B  
Bein



204-0006  
Fig. 6B  
Bein



204-0007  
Fig. 4SA  
Schmeckebeier-Apexo



204-0008  
Fig. 5SA  
Schmeckebeier-Apexo



204-0009  
Fig. 34S  
Seldin



204-0010  
Fig. 34  
Seldin



204-0011  
Fig. 2S  
Seldin



204-0012  
Fig. 3S  
Seldin



204-0013  
Fig. 1F  
Flohr



204-0014  
Fig. 2F  
Flohr



204-0015  
Fig. 3F  
Flohr

**ROOT ELEVATORS ●●●**

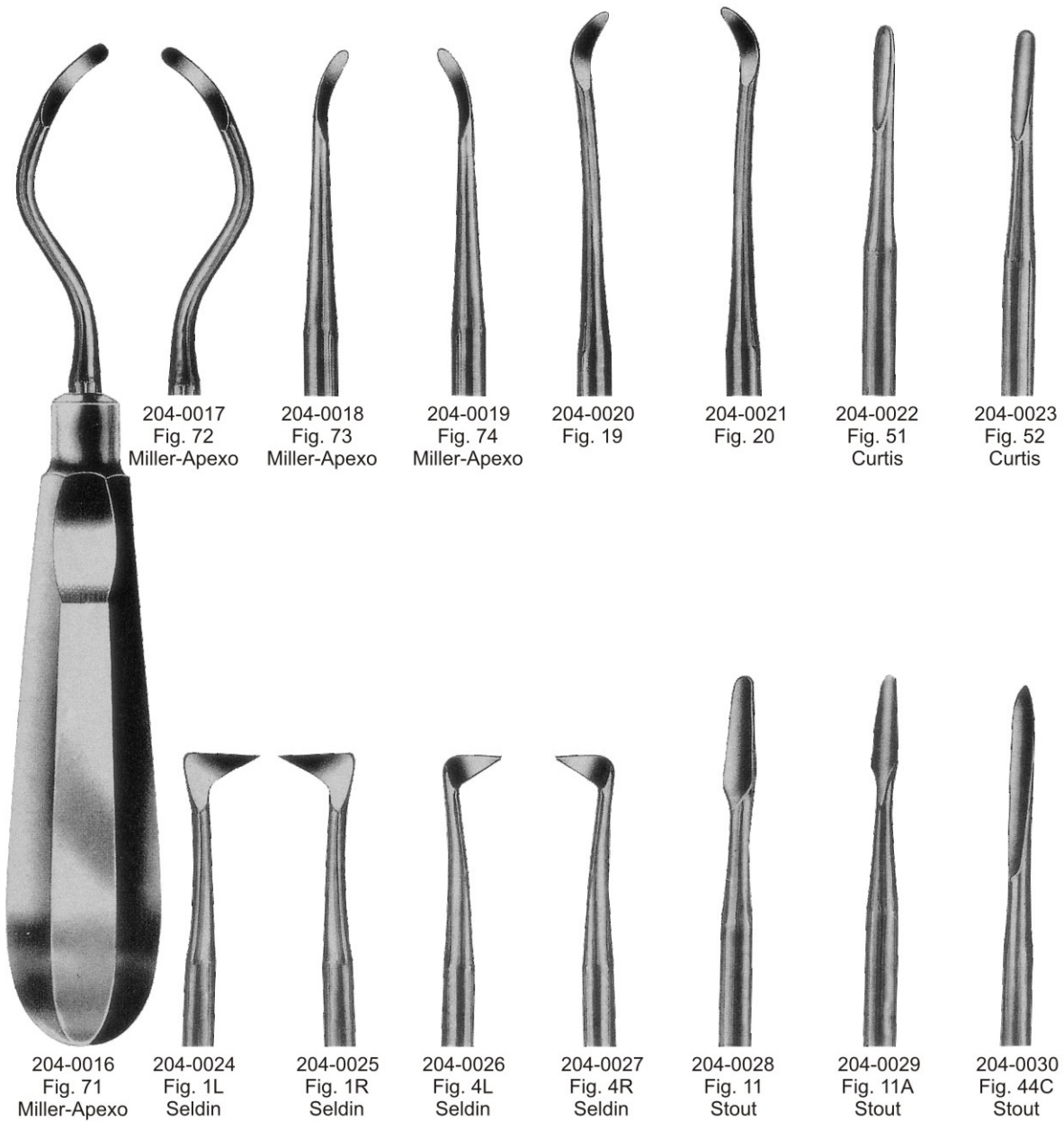

●●● ROOT ELEVATORS

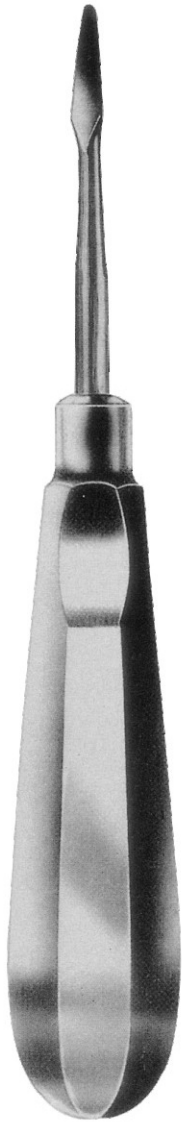

204-0031  
Fig. A  
Cogswell



204-0032  
Fig. B  
Cogswell



204-0033  
Fig. 301  
Apexo



204-0034  
Fig. 302  
Apexo



204-0035  
Fig. 303  
Apexo



204-0036  
Fig. 301W  
Seldin



204-0037  
Fig. 304W  
Seldin



204-0038  
Fig. 1H  
Heidbrink



204-0039  
Fig. 2H  
Heidbrink



204-0040  
Fig. 40H  
Heidbrink



204-0041  
Fig. 41H  
Heidbrink



204-0042  
Fig. 46



204-0043  
Fig. 46R



**ROOT ELEVATORS ●●●**

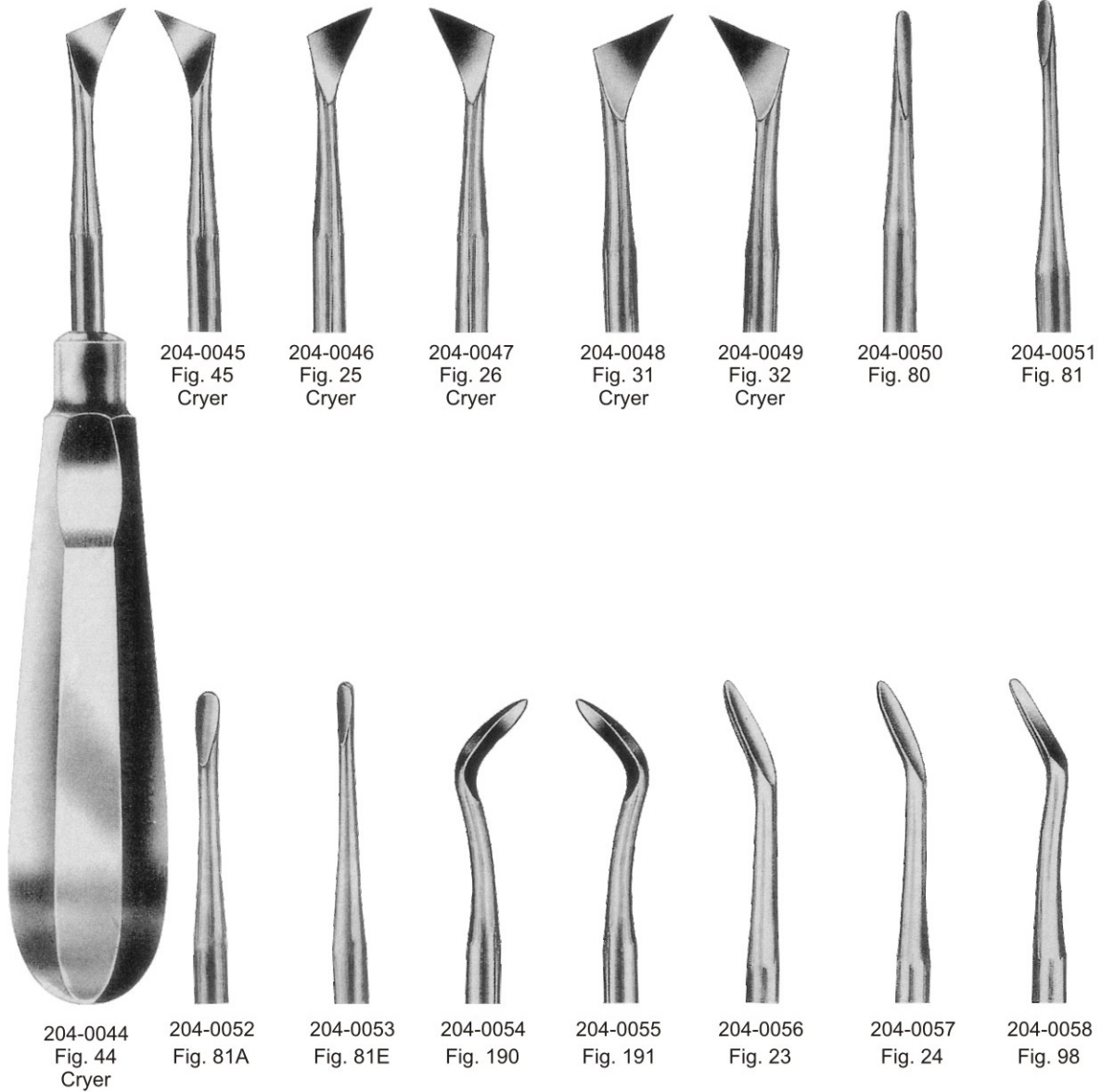

●●● ROOT ELEVATORS

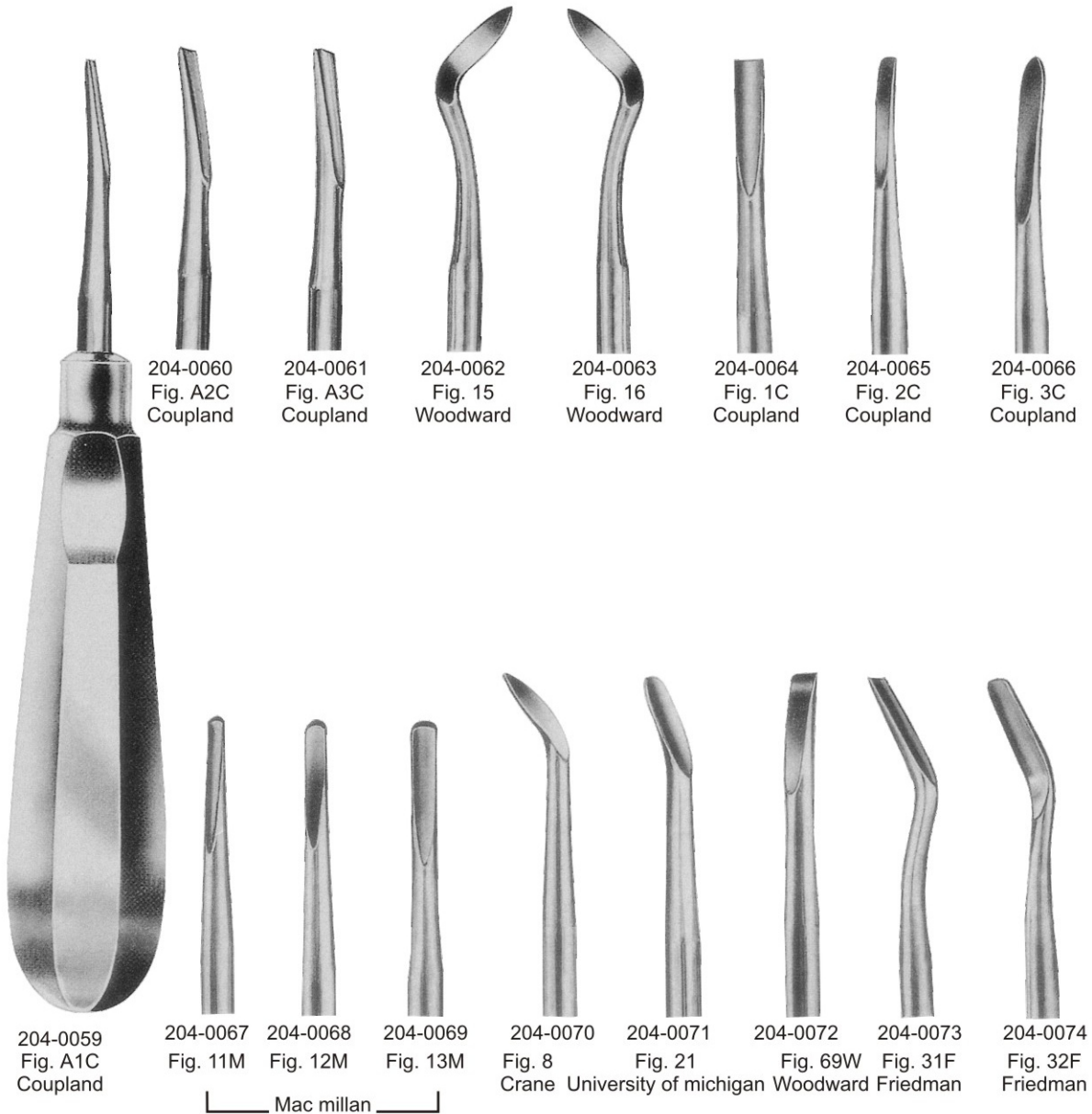

ROOT ELEVATORS ●●●

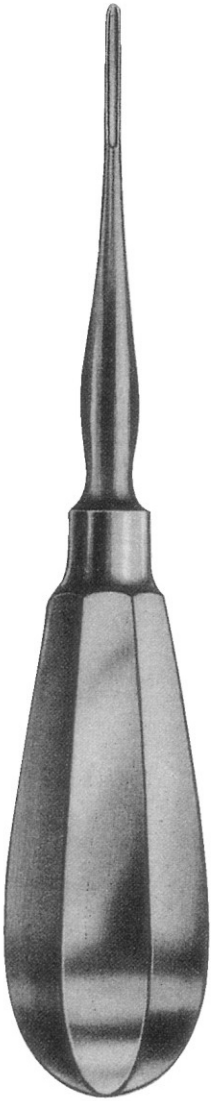

204-0075  
Fig. 1  
Bein



204-0076  
Fig. 2  
Bein



204-0077  
Fig. 3  
Bein



204-0078  
Fig. 4  
Bein



204-0079  
Fig. 5  
Bein



204-0080  
Fig. 6  
Bein



204-0081  
Fig. 1



204-0082  
Fig. 2



204-0083  
Fig. 2  
Flohr



204-0084  
Fig. 3  
Flohr



204-0085  
Fig. 3  
Cryer



204-0086  
Fig. 8  
Cryer



●●● ROOT ELEVATORS

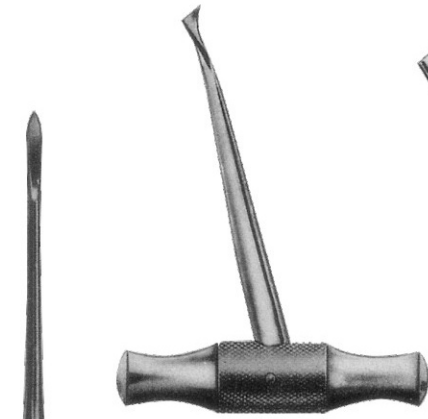

204-0087  
Walter F. Barry



204-0088  
Fig. 320



204-0089  
Fig. 321



204-0090  
Fig. 322



204-0091  
Fig. 323

Walter F. Barry



204-0093  
Fig. 2  
Heidbrink



204-0094  
Fig. 3  
Heidbrink

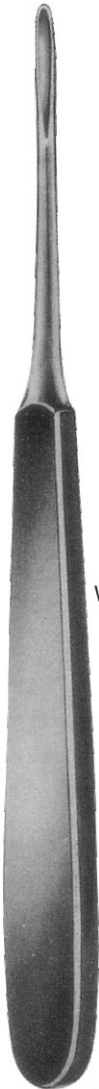

204-0101  
Fig. 2

Warwick-james

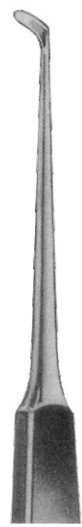

204-0102  
Fig. 3

Warwick-james

204-0092  
Fig. 1  
Heidbrink

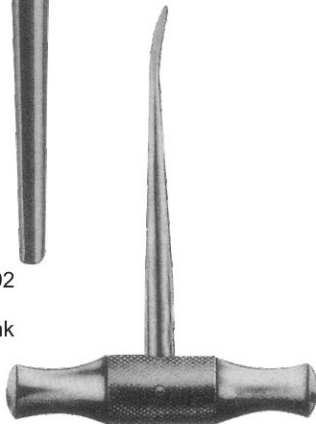

204-0095  
Winter

Winter



204-0096  
Fig. 11LW



204-0097  
Fig. 11RW



204-0098  
Fig. 12LW



204-0099  
Fig. 12RW

204-0100  
Fig. 1  
Warwick-james

**ORTHODONTICS INSTRUMENTS ●●●**



205-0001  
Band seating &  
removing instruments



205-0002



205-0003



205-0004  
Elastic instruments

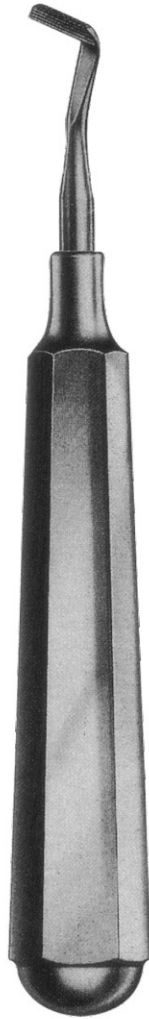

205-0005  
Mershon band pusher  
14cm



205-0006  
Band setter with  
tin insert  
15cm



205-0007  
13.5 cm

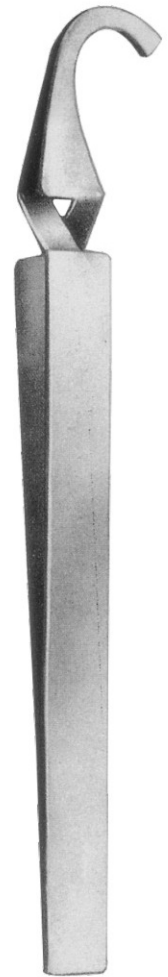

205-0008  
14cm

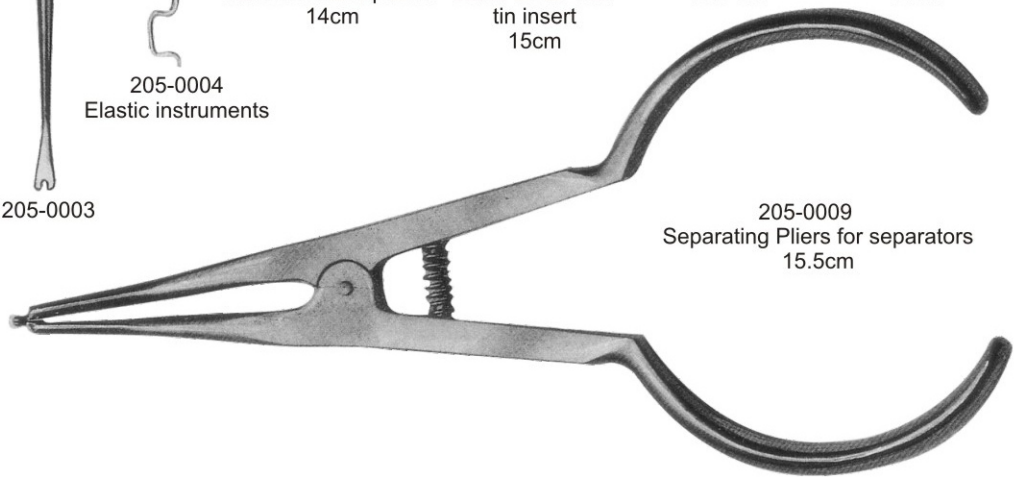

205-0009  
Separating Pliers for separators  
15.5cm

●●● ORTHODONTICS INSTRUMENTS



205-0010  
Mathieu pliers  
14cm



205-0011  
Elastic ligature placing pliers  
14cm



205-0012  
Mathieu ligating pliers  
14cm



205-0013  
Mathieu pliers  
with finger ring  
14cm

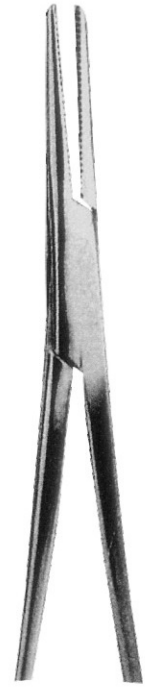

205-0014  
Straight 5"  
Mosquito Forceps  
205-0015  
Curved 5"



205-0016  
Ligature tying piler

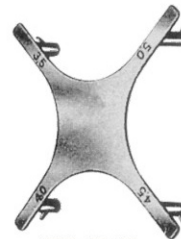

205-0017  
Bracket positioning gauge

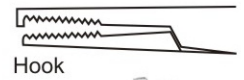

Hook



205-0022  
Band seating  
instruments  
nylon

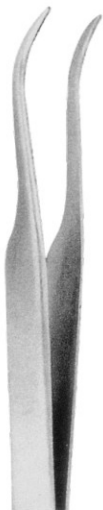

205-0018  
Bracket placing  
tweezer



205-0019  
Bracket placing  
tweezer



205-0020  
Clamping  
Tweezer



205-0021  
Bracket holding  
tweezer



205-0022  
Band seating  
instruments  
nylon

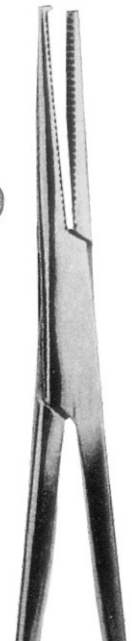

205-0023  
Straight 5"  
Mosquito Forceps  
205-0024  
Curved 5"



GUM SCISSORS ●●●



206-0001  
Fig. 1  
12cm Straight

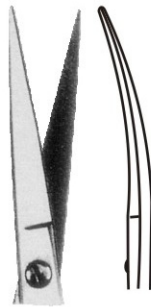

206-0002  
Fig. 2  
12cm curved



206-0003  
Fig. 1  
13cm  
Goldman-Fox  
Saw edge  
Straight

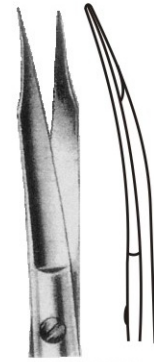

206-0004  
Fig. 2  
13cm  
Goldman-Fox  
Saw edge  
curved

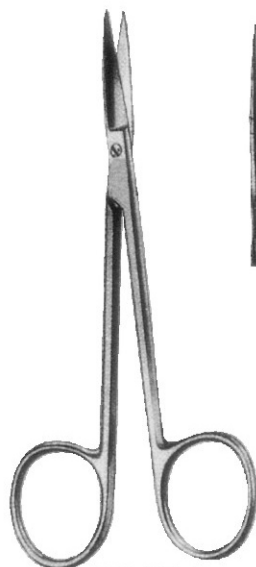

206-0005  
Fig. 1  
11.5cm  
Iris Straight

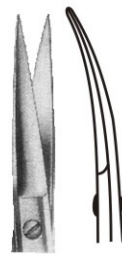

206-0006  
Fig. 2  
11.5cm  
Iris  
Curved



206-0007  
Fig. 3  
11.5cm  
Iris



206-0008  
Fig. 1  
11.5cm  
Angular Saw edge



206-0009  
Fig. 2  
11.5cm  
Angular

●●● GUM SCISSORS

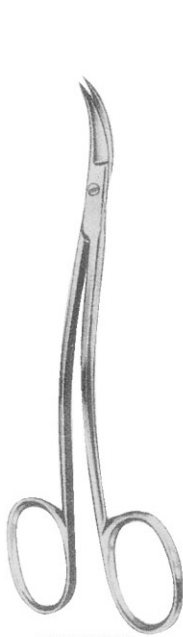

206-0010  
Fig. 1  
La Grange  
11.5cm

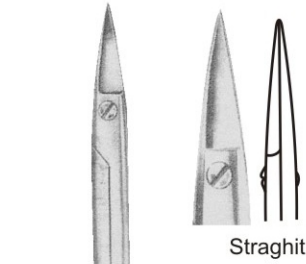

206-0011  
Fig. 1  
Quinby  
12.5cm

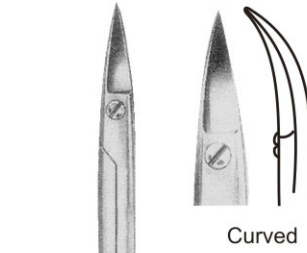

206-0012  
Fig. 2  
Quinby  
12.5cm



206-0013  
Fig. 3  
Goldman-Fox (Special)  
saw edge  
12.5cm

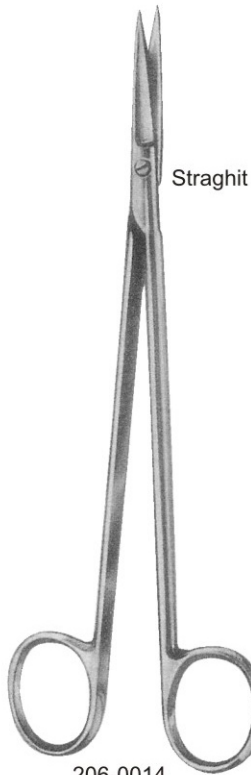

206-0014  
Fig. 1  
Kelly  
16cm

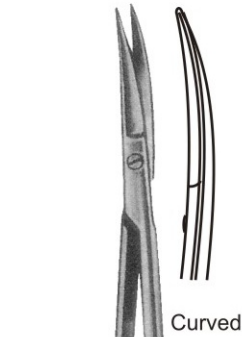

206-0015  
Fig. 2  
Kelly  
16cm

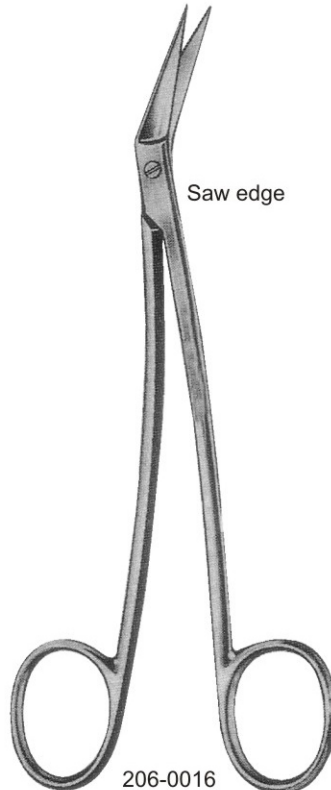

206-0016  
Fig. 1  
Locklin  
16.5 cm

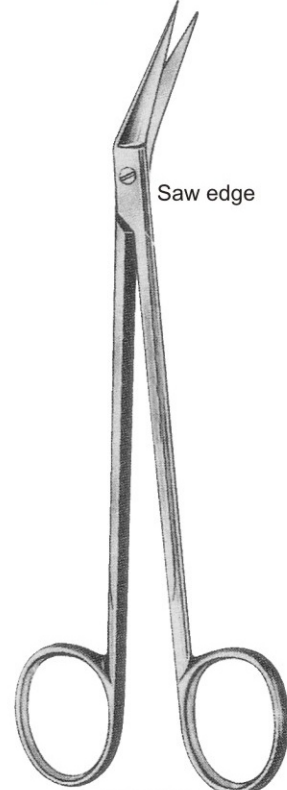

206-0017  
Fig. 2  
Locklin  
16.5cm

**SURGICAL SCISSORS ●●●**

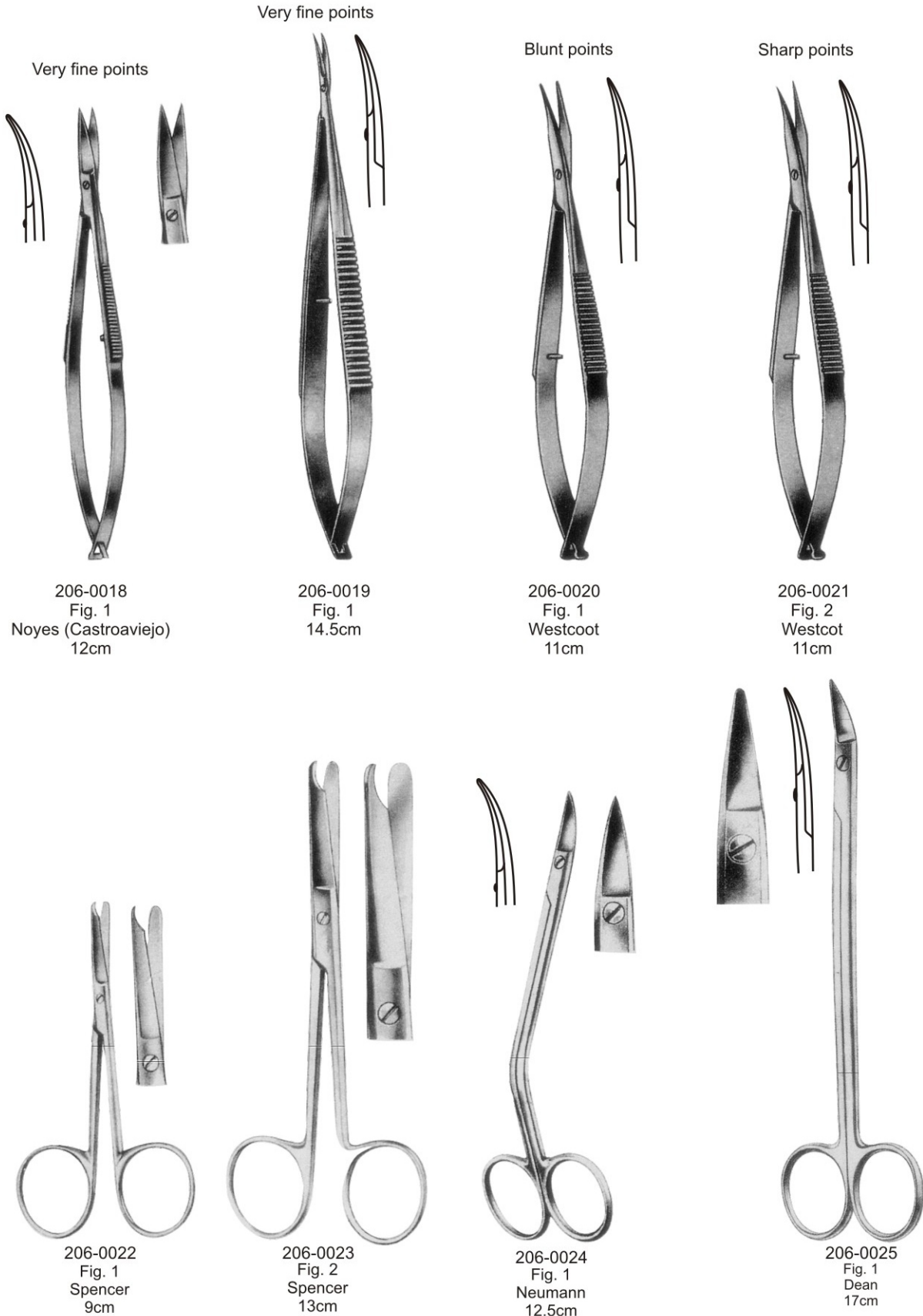

Very fine points

206-0018  
Fig. 1  
Noyes (Castroaviejo)  
12cm

Very fine points

206-0019  
Fig. 1  
14.5cm

Blunt points

206-0020  
Fig. 1  
Westcott  
11cm

Sharp points

206-0021  
Fig. 2  
Westcott  
11cm

206-0022  
Fig. 1  
Spencer  
9cm

206-0023  
Fig. 2  
Spencer  
13cm

206-0024  
Fig. 1  
Neumann  
12.5cm

206-0025  
Fig. 1  
Dean  
17cm



●●● SURGICAL SCISSORS

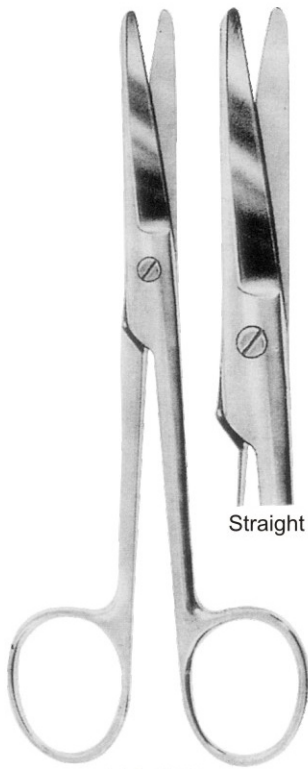

Straight

206-0026  
Fig. 1  
Mayo  
14.5cm

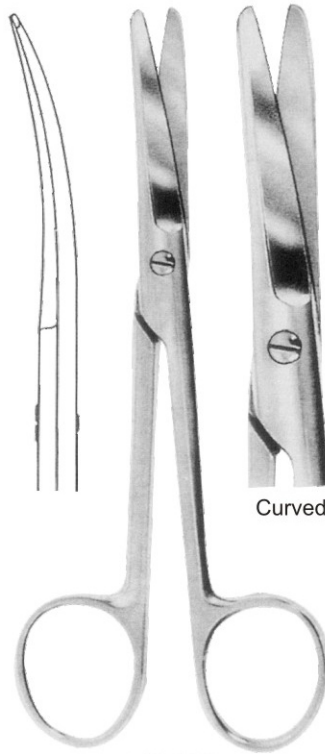

Curved

206-0027  
Fig. 2  
Mayo  
14.5cm

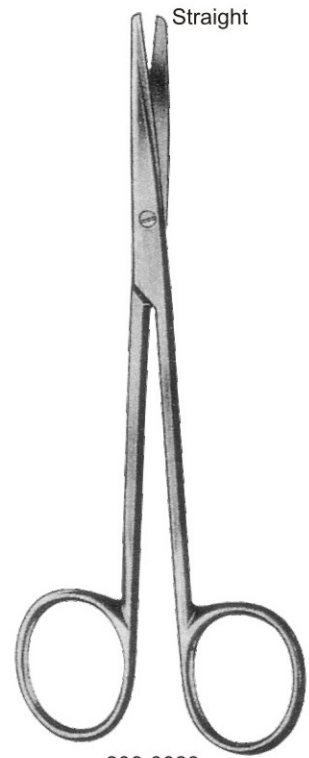

Straight

206-0028  
Fig. 2  
Metzenbaum  
14.5cm

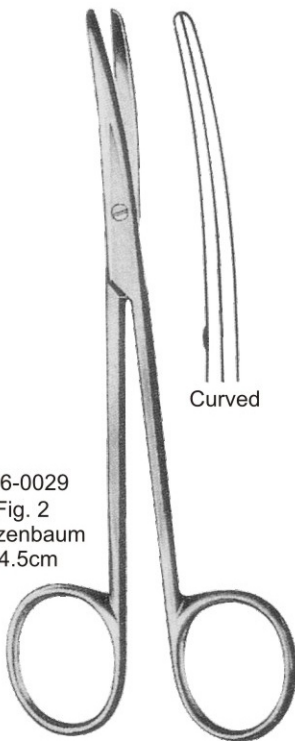

Curved

206-0029  
Fig. 2  
Metzenbaum  
14.5cm

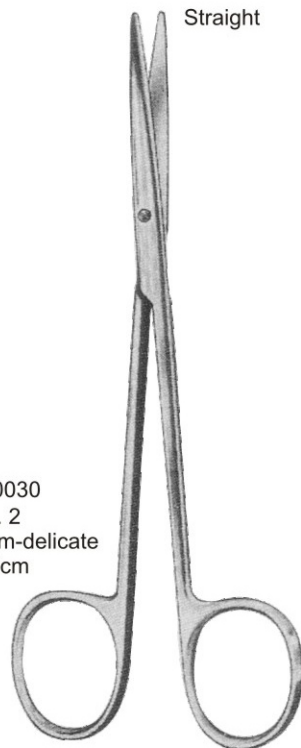

Straight

206-0030  
Fig. 2  
Metzenbaum-delicate  
14.5cm

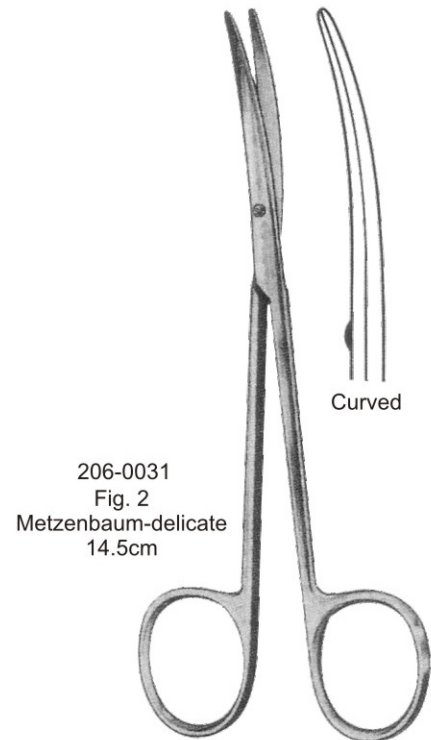

Curved

206-0031  
Fig. 2  
Metzenbaum-delicate  
14.5cm

**HAEMOSTATIC FORCEPS ●●●**

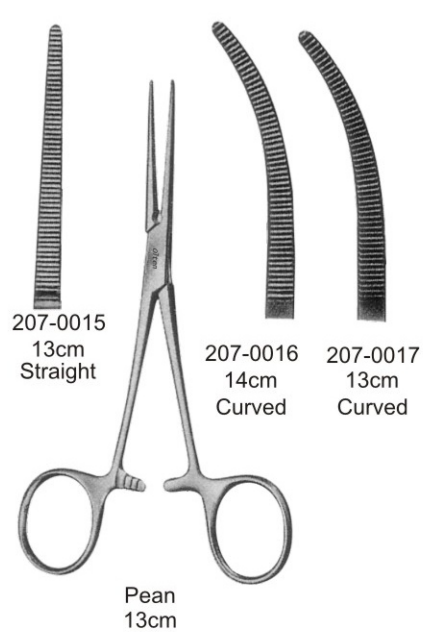
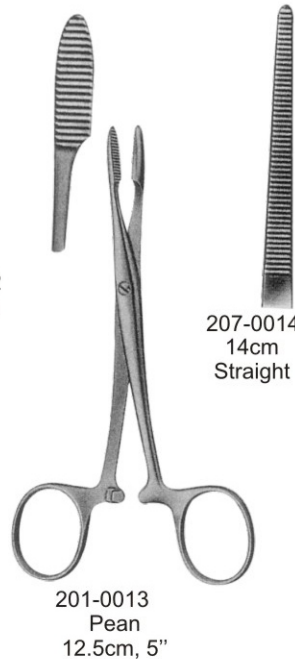
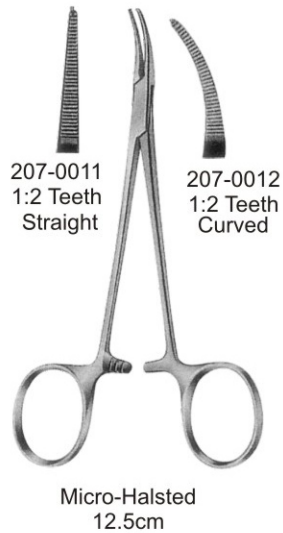
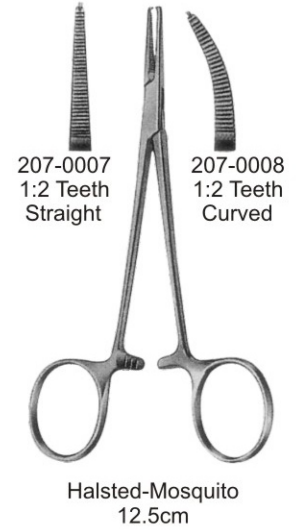
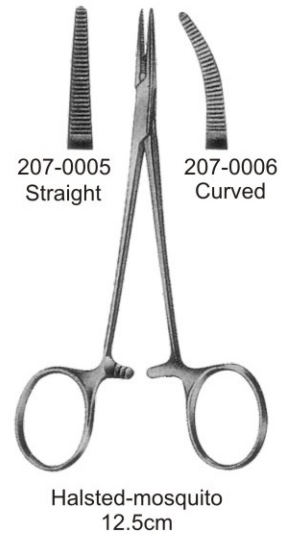

●●● HAEMOSTATIC FORCEPS

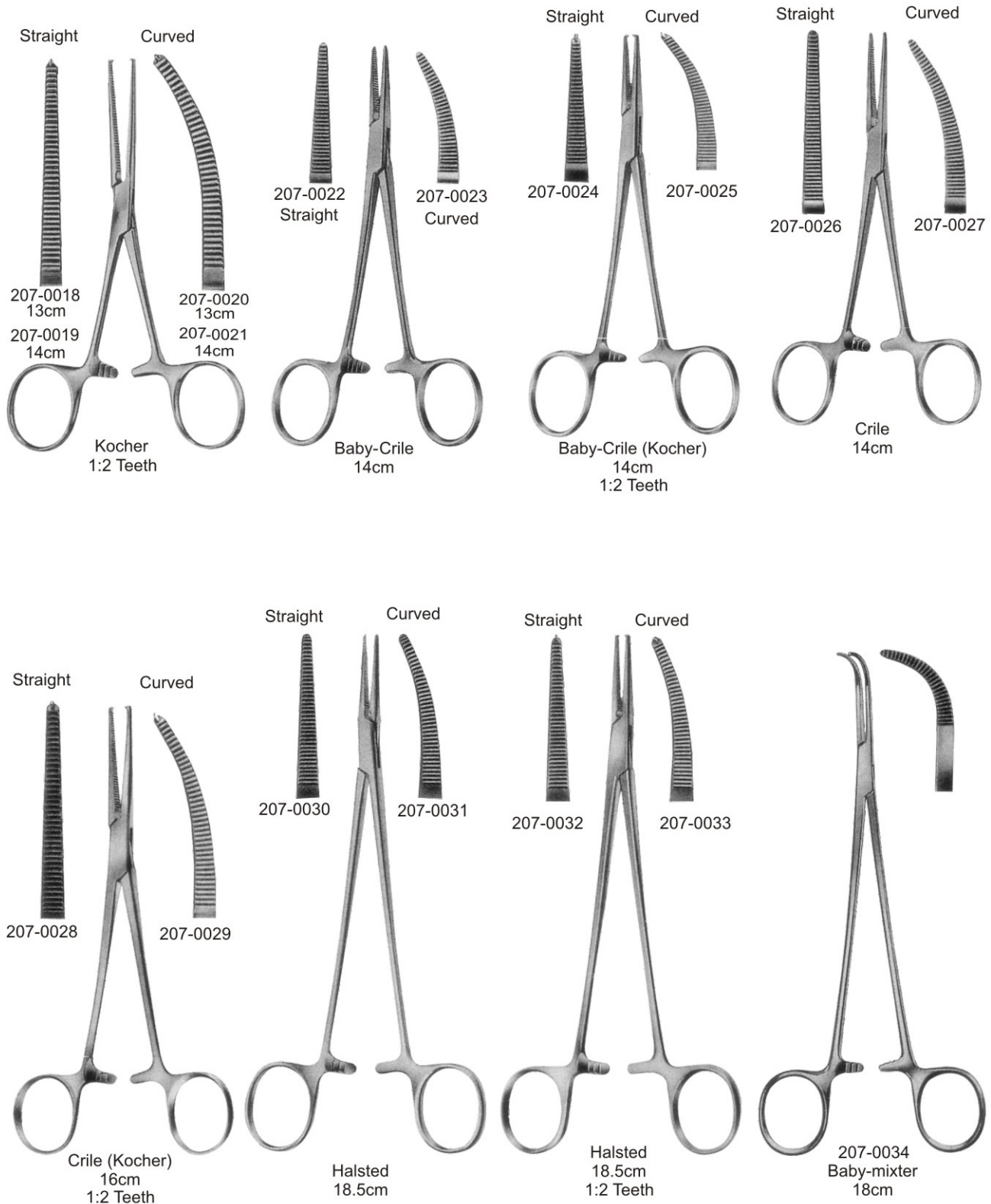



SPONGE AND DRESSING FORCEPS ●●●



207-0035  
Without Ratchet  
14.5cm



207-0036  
With Ratchet  
14.5cm



207-0037  
Curved  
17.5cm

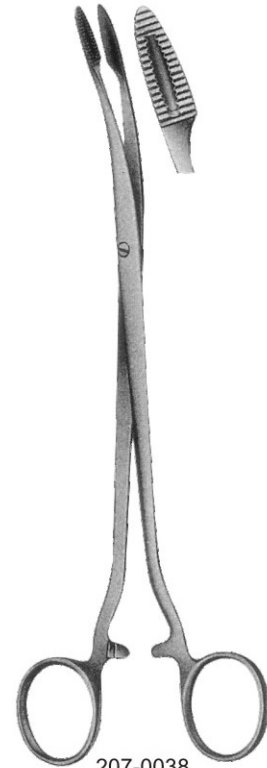

207-0038  
Curved  
21cm

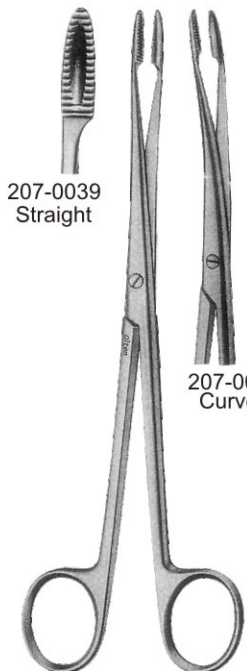

207-0039  
Straight

Without Ratchet  
18cm

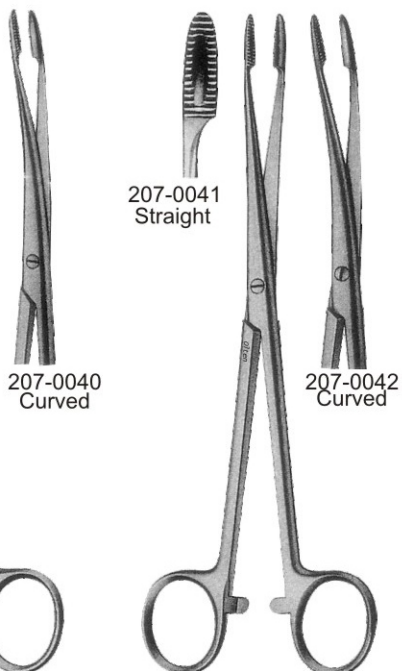

207-0040  
Curved

With Ratchet  
18cm

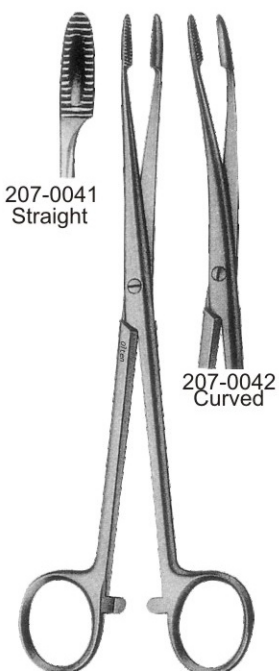

207-0041  
Straight



207-0042  
Curved

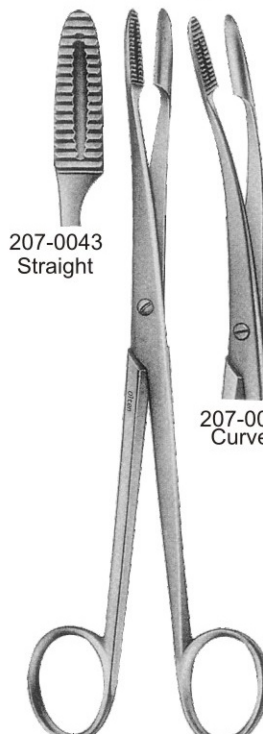

207-0043  
Straight

Without Ratchet  
20cm



207-0044  
Curved

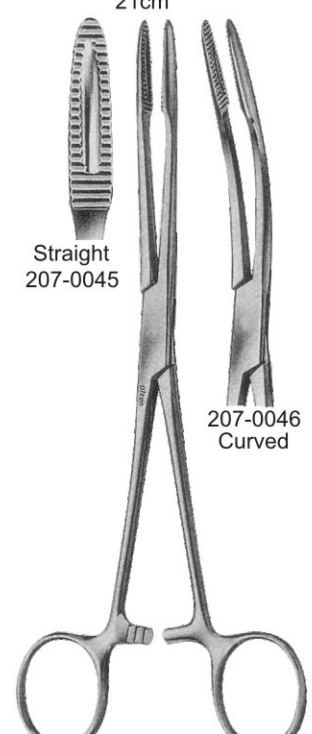

Straight  
207-0045

With Ratchet  
20cm



207-0046  
Curved

●●● **TOWEL CLAMPS** Sterilizing Forceps For Sterile Instruments

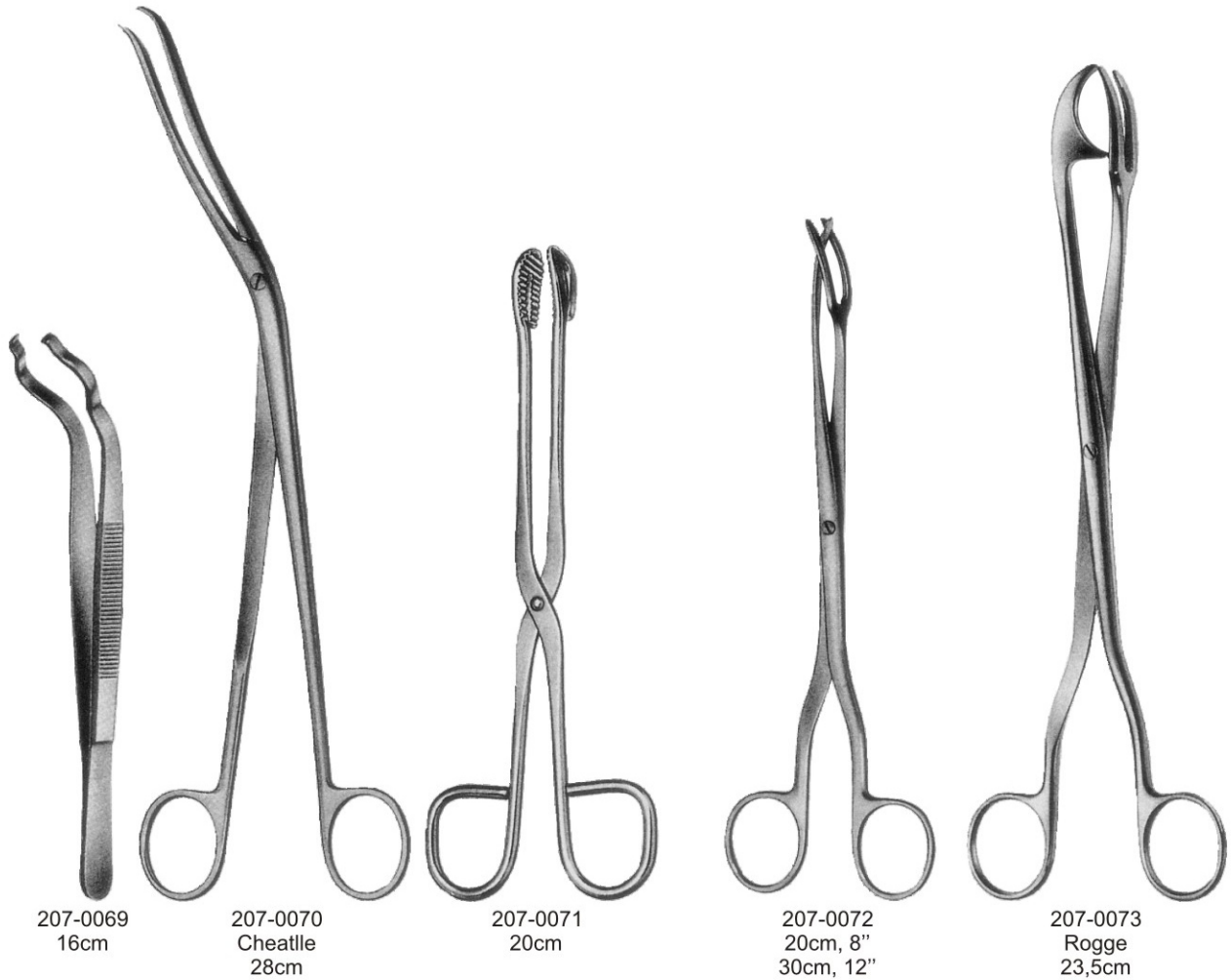
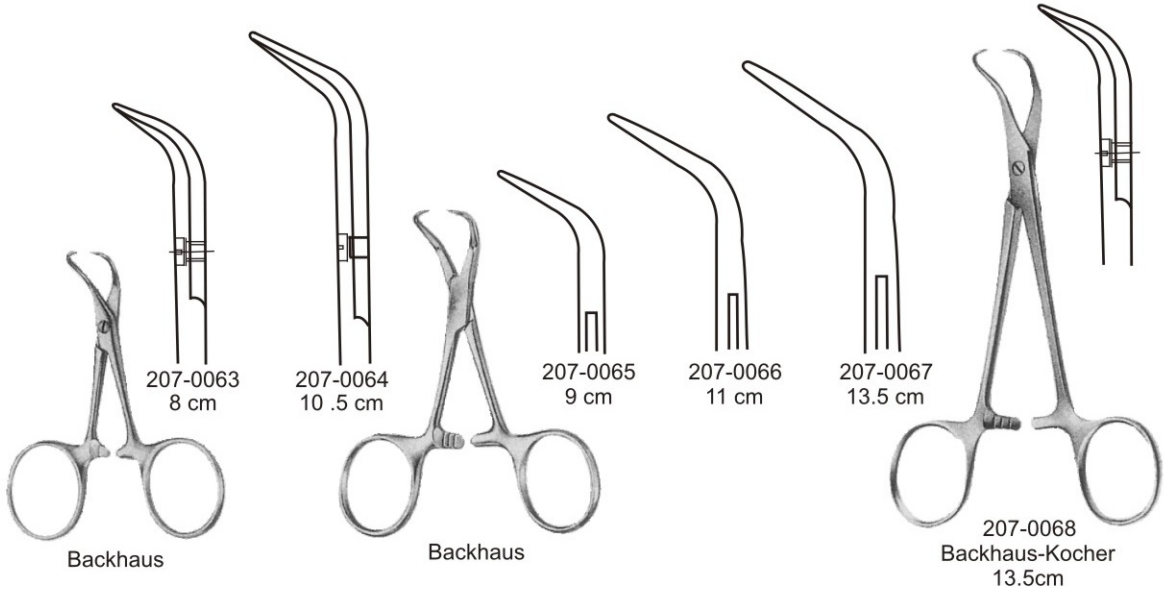

**SKIN HOOK & RETRACTORS ●●●**

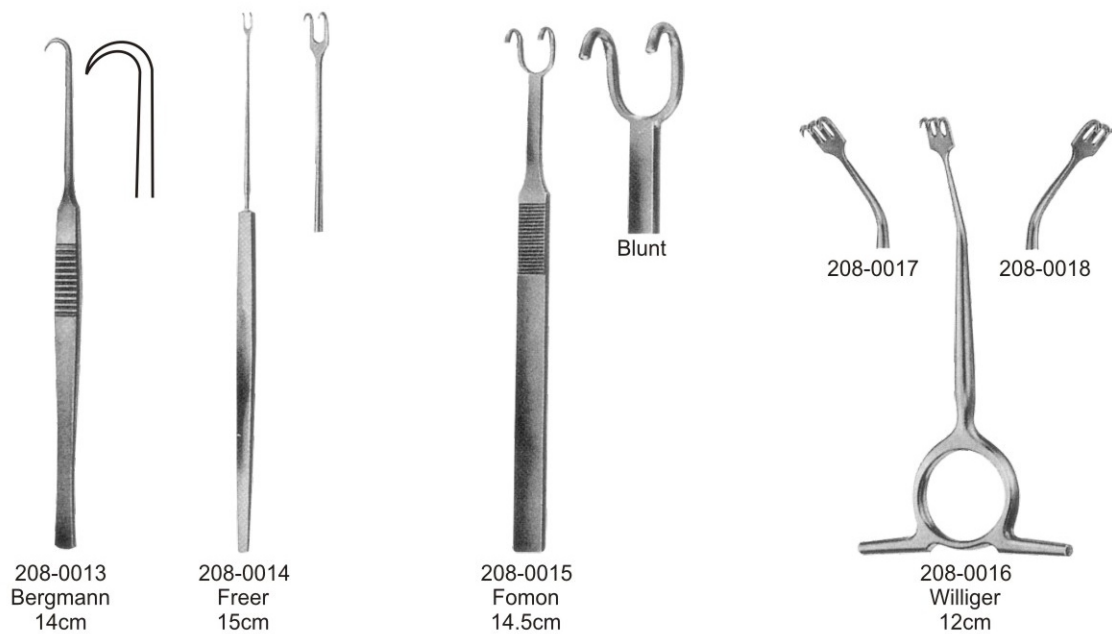
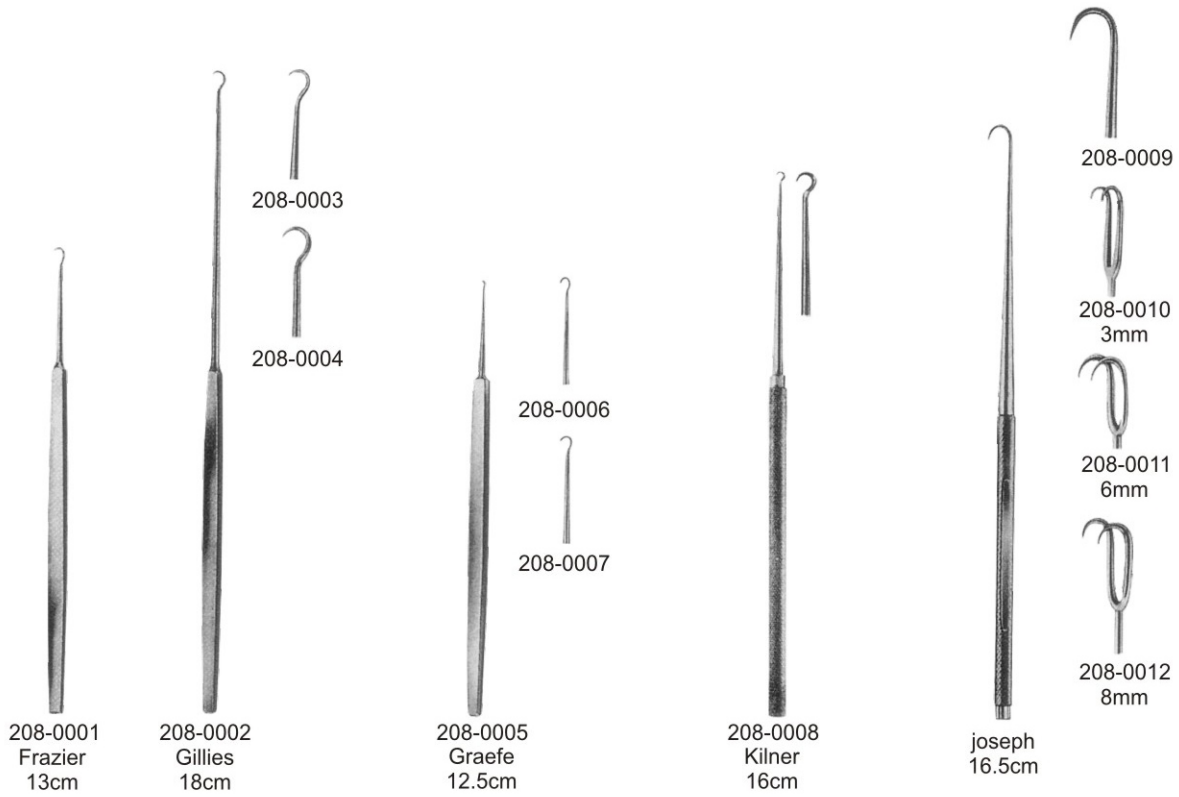



●●● **RETRACTORS**

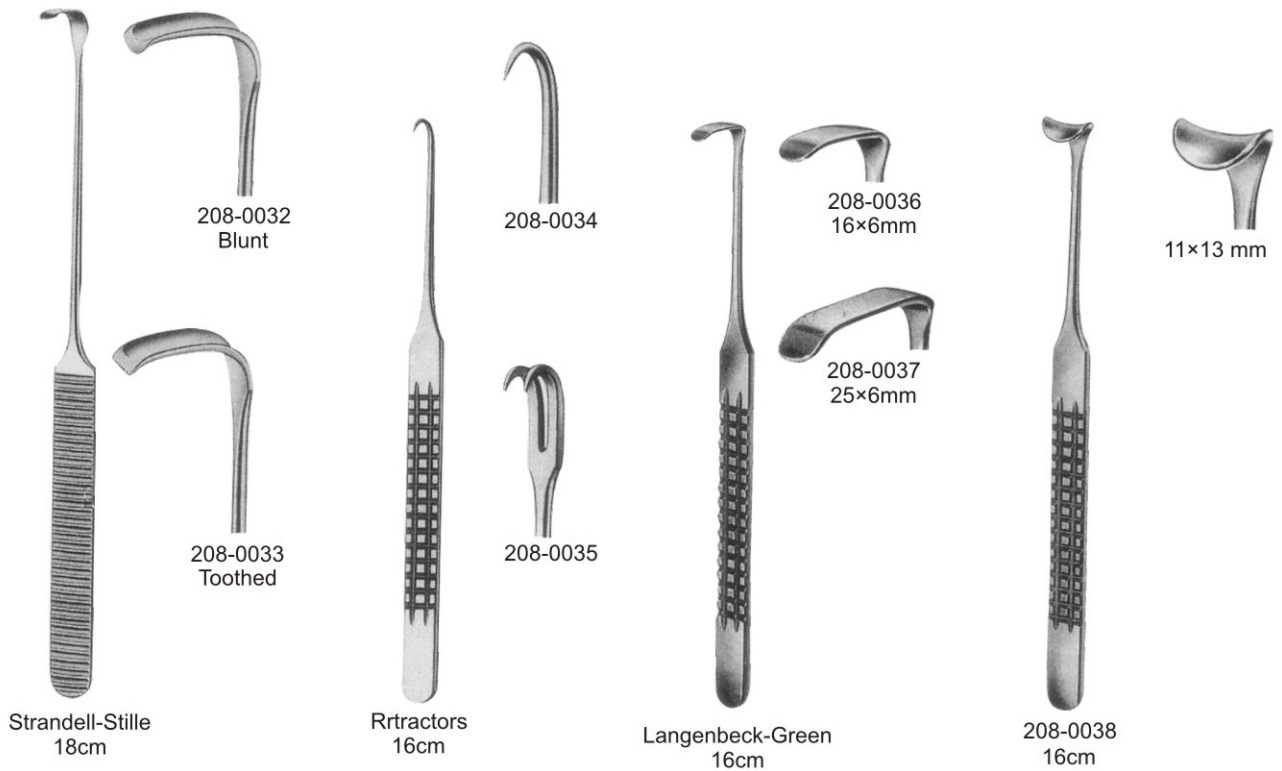
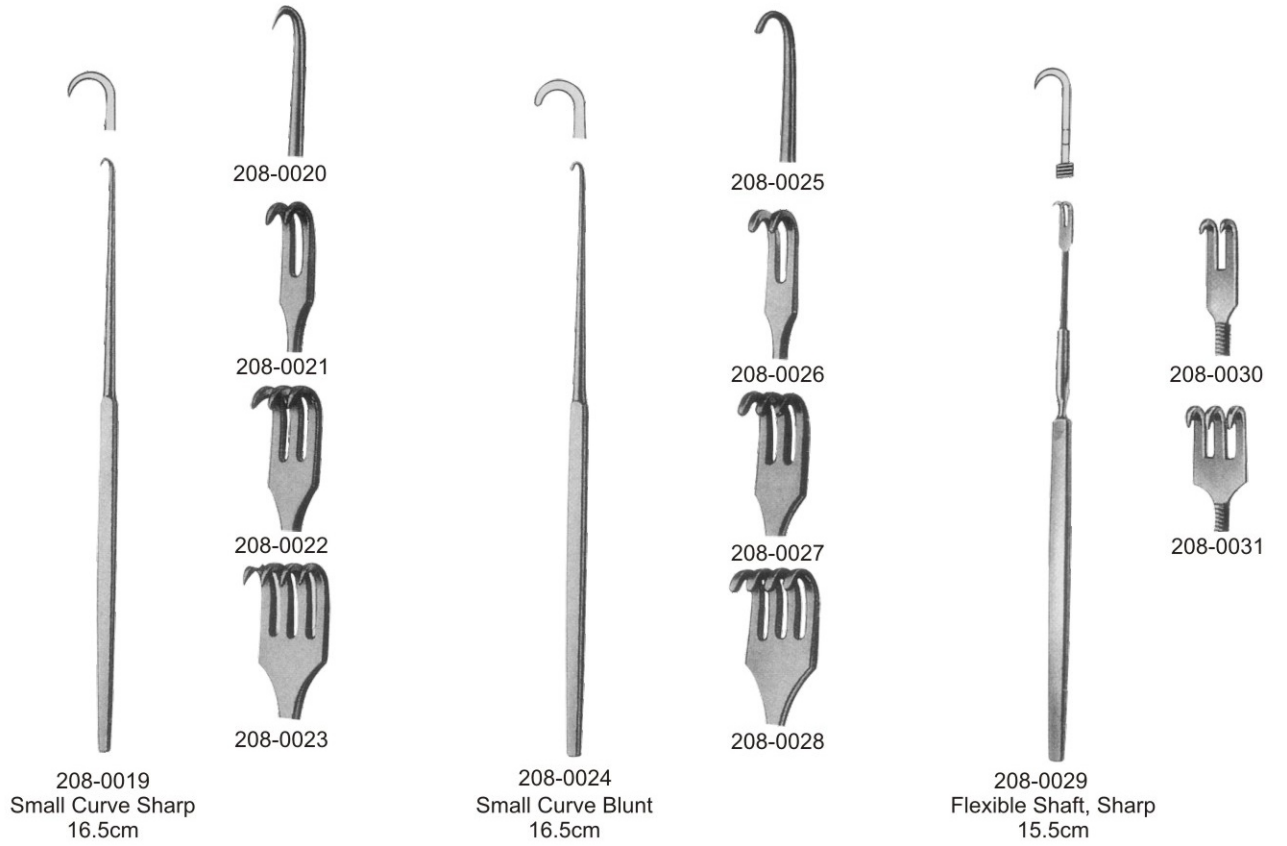

**RETRACTORS ●●●**

25×10mm  
22×10mm

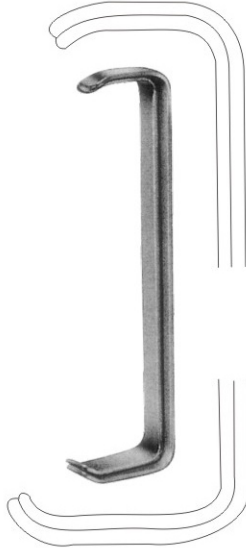

28×12mm  
32×12mm  
**208-0039**  
Farabeuf (Set of 2Pcs)  
12.5cm

23×16mm  
20×16mm

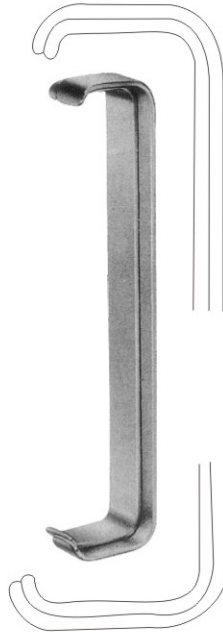

24×16mm  
28×16mm  
**208-0040**  
Farabeuf (Set of 2Pcs)  
15cm

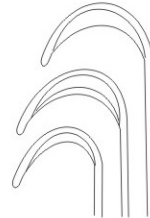

**208-0041** 19×22mm  
23×30mm  
**208-0042** 25×26mm  
28×38mm  
**208-0043** 28×29mm  
33×45mm

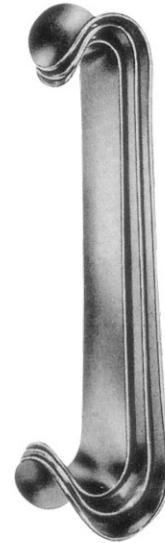

Farabeuf (Set of 3Pcs)  
16.5cm



**208-0044**  
30×10mm

**208-0045**  
40×10mm

**208-0046**  
43×13mm



Langenbeck  
23cm



**208-0047**  
25×6mm

**208-0048**  
35×8mm

**208-0049**  
35×11mm

**208-0050**  
35×15mm

**208-0051**  
41×11mm

**208-0052**  
55×11mm



Kocher-Langenbeck  
21.5cm

●●● CHEEK RETRACTORS



Middeldorpf



208-0053  
15×15mm  
22cm



208-0054  
20×22mm  
21.5cm



208-0055  
28×28mm  
23.5cm



208-0056  
Greene  
22.5cm



208-0057  
Buchs  
20.5cm



208-0058  
28×10mm



208-0059  
28×14mm



208-0060  
33×14mm



208-0061  
28×16mm

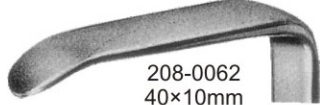

208-0062  
40×10mm

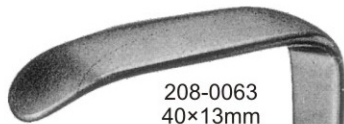

208-0063  
40×13mm



Langenbeck  
21cm

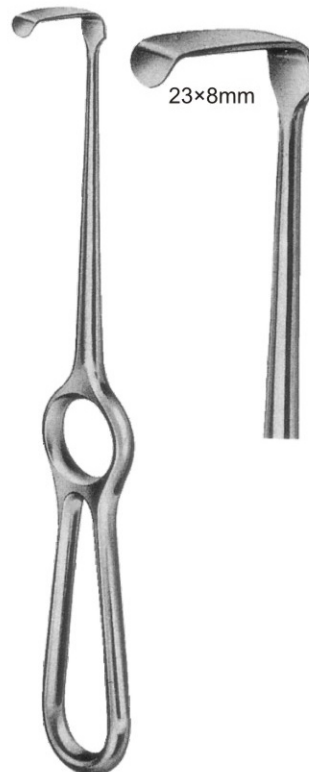

208-0064  
Kocher  
21cm



208-0065  
Alm (Sharp)  
7cm



208-0066  
Blunt



208-0067  
Alm (Sharp)  
10cm

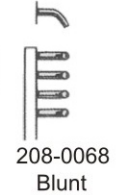

208-0068  
Blunt



**ELEVATORS** ●●●

5mm

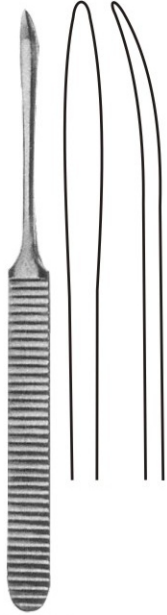

208-0069  
Williger  
16.5cm

6mm

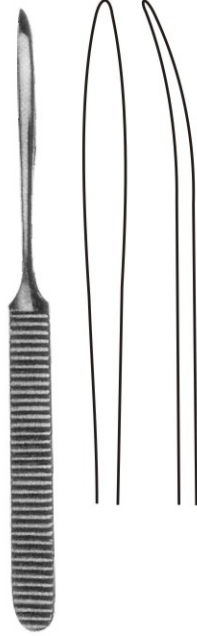

208-0070  
Williger  
17cm

4.5mm

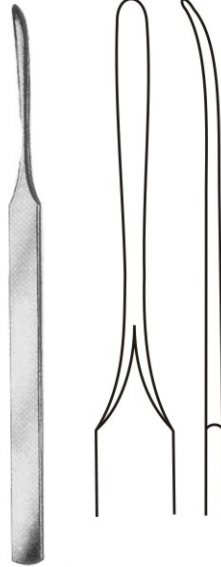

208-0071  
Konig  
15.5cm

4.5mm

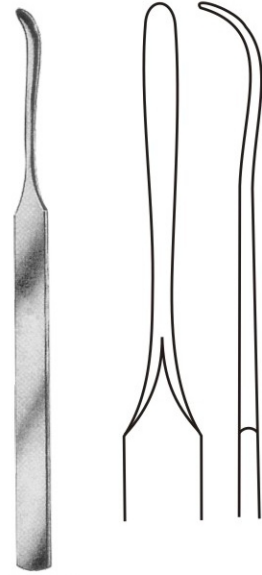

208-0072  
Konig  
15.5cm



208-0073  
Freer  
19cm

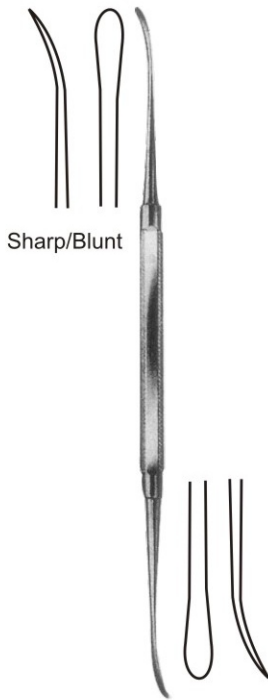

208-0074  
Freer  
18.5cm



208-0075  
Freer-Yasargil  
18.5cm

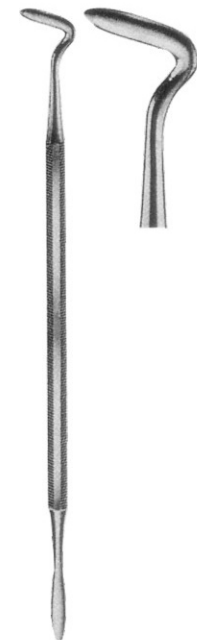

208-0076  
Kendzia  
17cm

●●● **ELEVATORS**

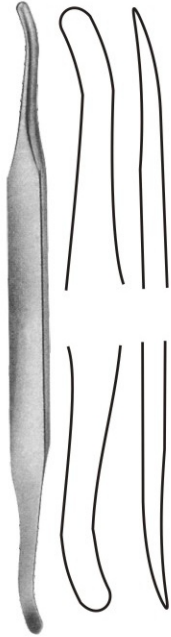

208-0077  
Scladin  
19.5cm

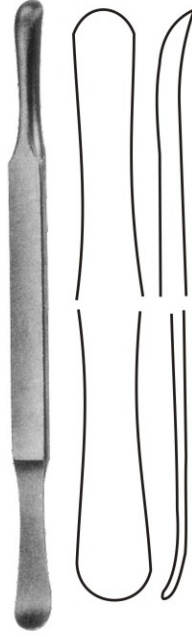

208-0078  
Scladin  
19.5cm



208-0079  
Chompret  
15cm

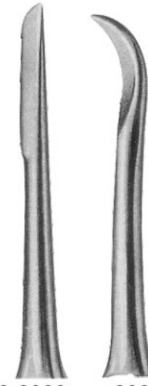

208-0080      208-0081

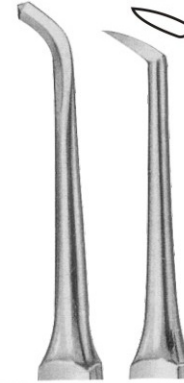

208-0082      208-0083

4 mm

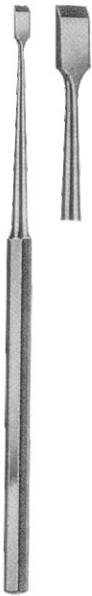

208-0084  
Freer  
16cm

4 mm



208-0085  
Freer  
16cm

4 mm



208-0086  
Partsch, mod  
14.5cm



208-0087  
Mead  
16.5cm

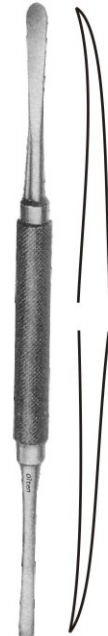

208-0088  
Mead  
18cm

**ELEVATORS** ●●●

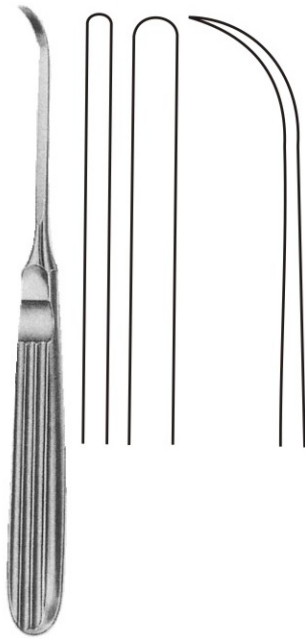

208-0089 (3m)  
208-0090 (6mm)  
Raspatories  
17cm

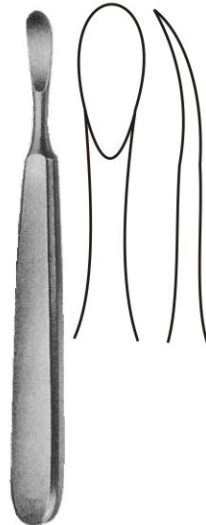

208-0091  
8mm  
Trelat  
14cm



208-0092  
Konig  
15.5cm

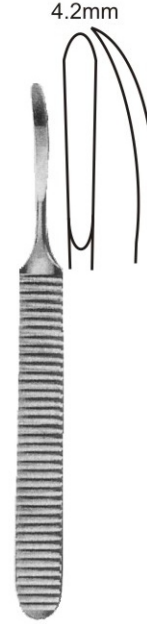

208-0093  
Williger  
14cm

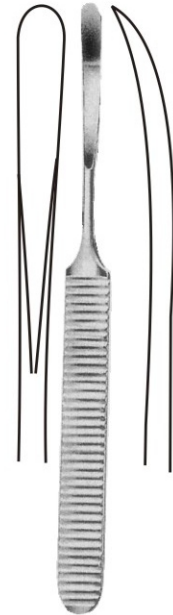

208-0094  
Williger  
16cm

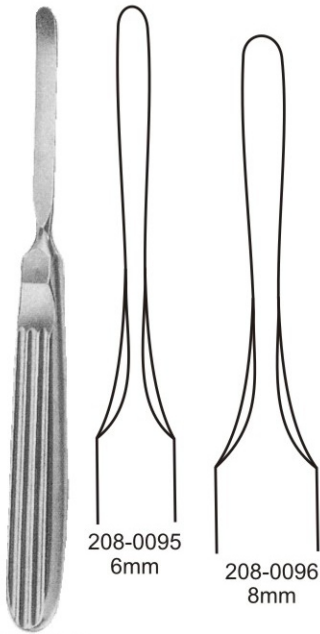

Raspatories  
16.5cm

208-0095  
6mm

208-0096  
8mm

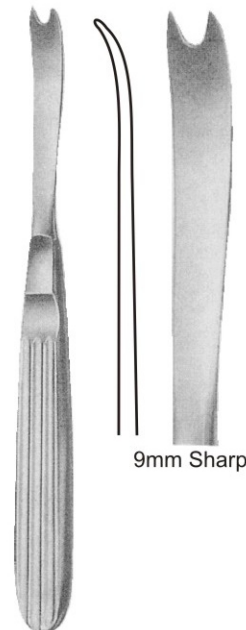

208-0097  
Obwegeser  
17cm

9mm Sharp



Raspatories  
20cm



208-0098  
5mm



208-0099  
8mm



208-0100  
Tessie  
22cm



●●● CHISELS & GOUGES

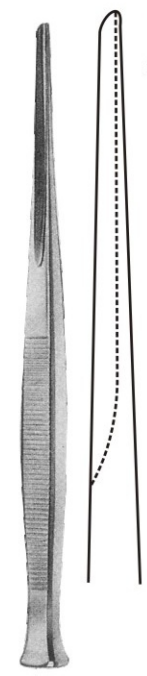

Partsch  
17cm

208-0101  
3mm  
208-0102  
4mm



208-0103  
Freer  
16cm

4mm

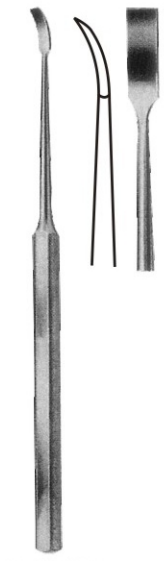

208-0104  
Freer  
16cm

4mm  
Curved



Lucas  
16cm

208-0105  
4mm  
208-0106  
6mm

208-0107  
3mm  
208-0108  
5mm



Lucas  
16cm

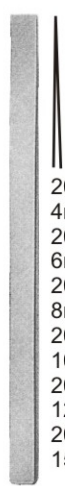

Lambotte  
12.5cm

208-0109  
4mm  
208-0110  
6mm  
208-0111  
8mm  
208-0112  
10mm  
208-0113  
12mm  
208-0114  
15mm



14cm

208-0115  
4mm  
208-0116  
6mm  
208-0117  
8mm



Partsch  
14cm

208-0118  
3mm  
208-0119  
4mm  
208-0120  
5mm  
208-0121  
6mm

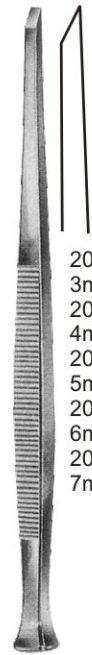

Partsch  
17cm

208-0122  
3mm  
208-0123  
4mm  
208-0124  
5mm  
208-0125  
6mm  
208-0126  
7mm

208-0127  
3mm  
208-0128  
4mm

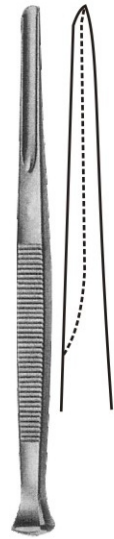

Partsch  
14cm

**RUBBER DAM INSTRUMENTS ●●●**

Calmp forceps



209-0001  
Ivory light weight  
17cm

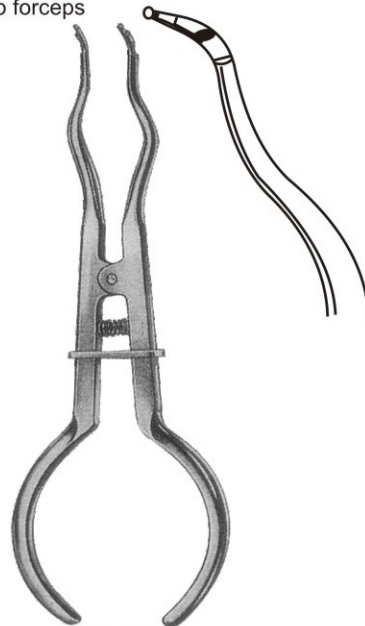

209-0002  
Brewer  
17.5cm

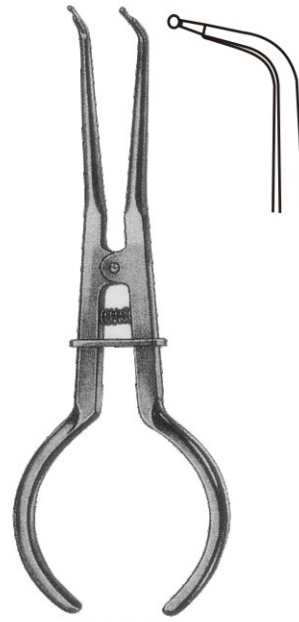

209-0003  
Stokes  
17.5cm

Punch forceps



209-0004  
Ainsworth  
17cm



209-0005  
Ivory  
17cm



209-0006  
Rubber dam frame

●●● TISSUE PLIERS

210-0001  
Adson, 12cm

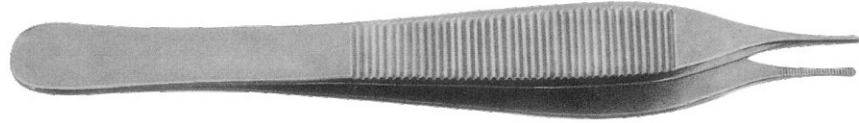

210-0002  
Adson1x2, 12cm

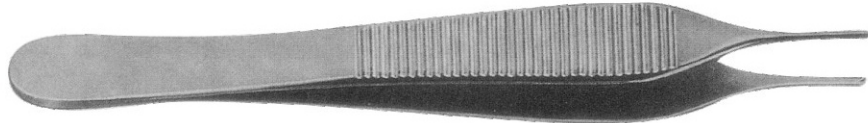

210-0003  
Fig. 1  
Semken-Taylor  
12.5 cm

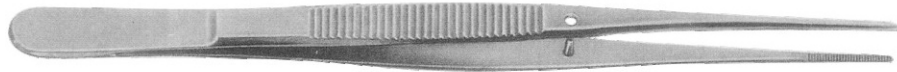

210-0004  
Fig. 2  
Semken-Taylor  
12.5cm

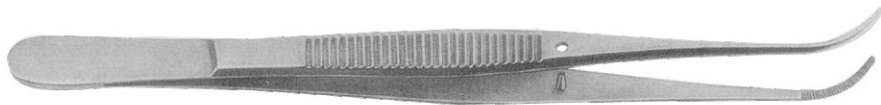

210-0005  
Fig. 1  
Semken-Taylor 1x2  
12.5cm

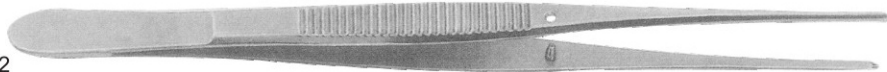

210-0006  
Fig. 2  
Semken-Taylor 1x2  
12.5cm

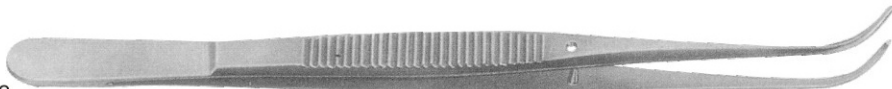

210-0007  
12cm

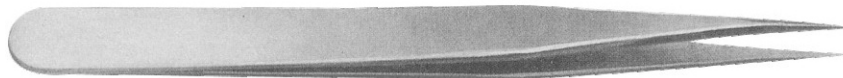

210-0008  
11.5cm

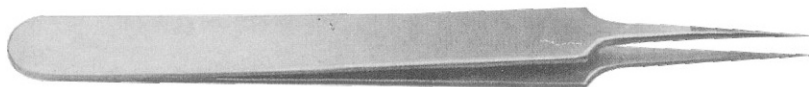

210-0009  
11.5cm



210-0010  
11.5cm

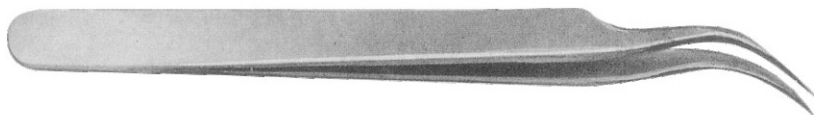



**COTTON AND DRESSING PLIERS ●●●**

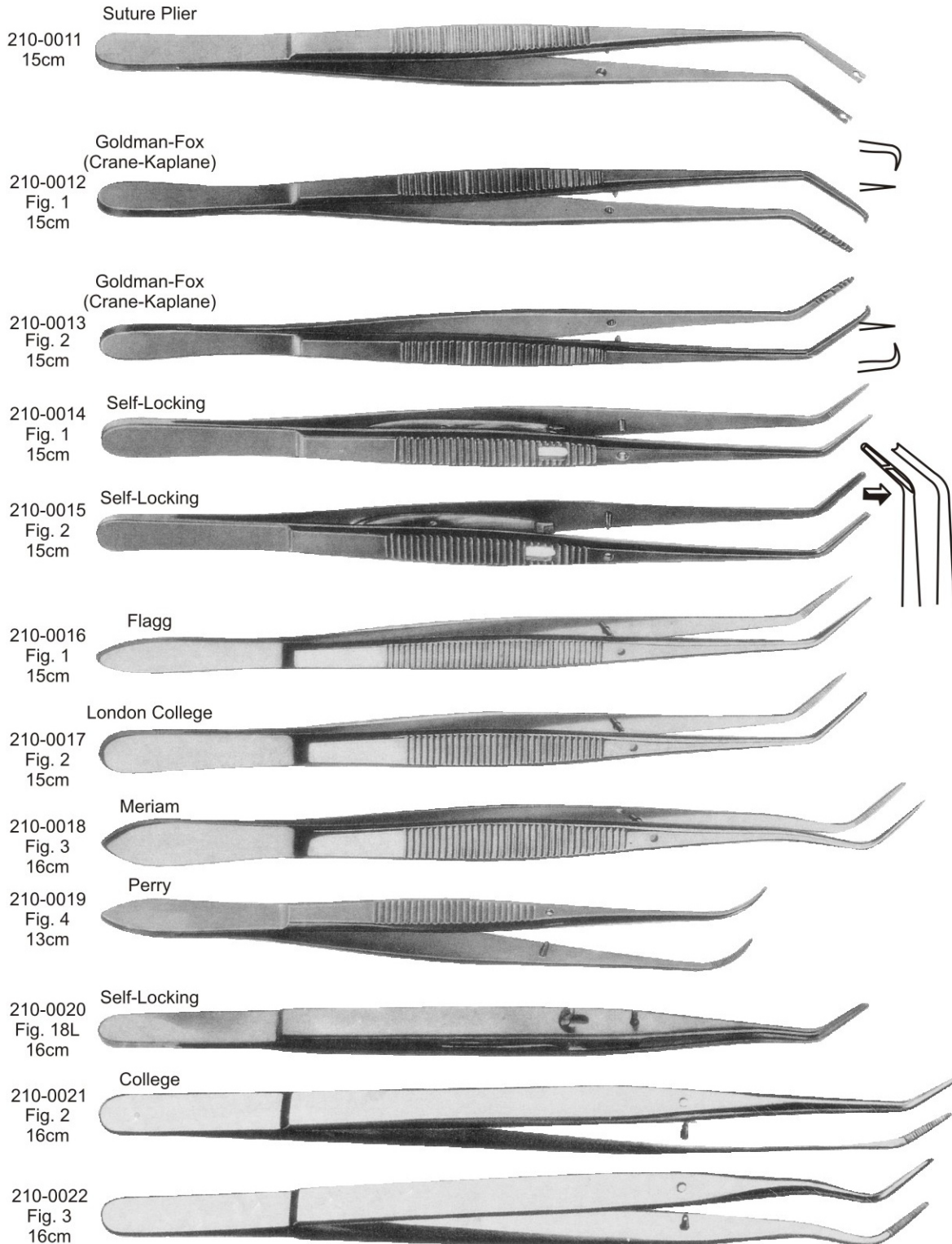

●●● SCALPEL HANDLES

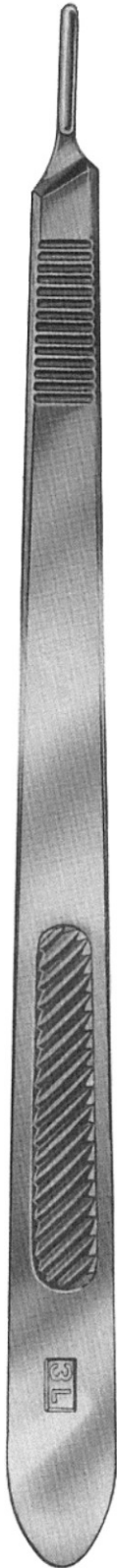

211-0001  
No.3L



211-0002  
ERGONOMIC



211-0003  
No.7

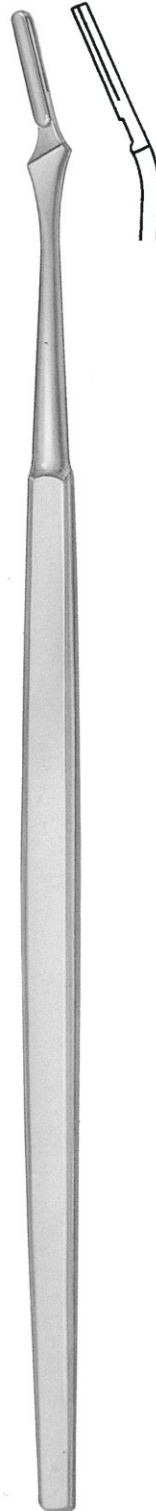

211-0004



211-0005

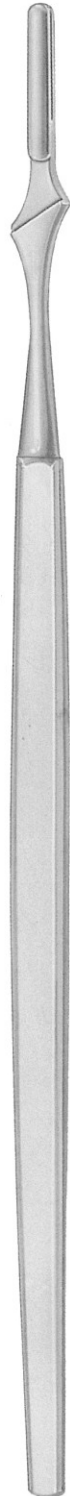

211-0006

**SCALPEL HANDLES** ● ● ●

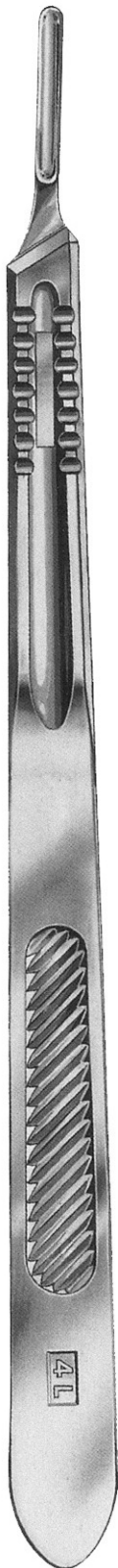

211-0007  
No.4L

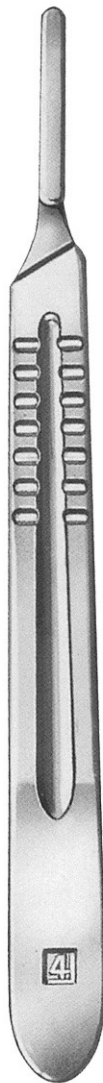

211-0008  
No.4

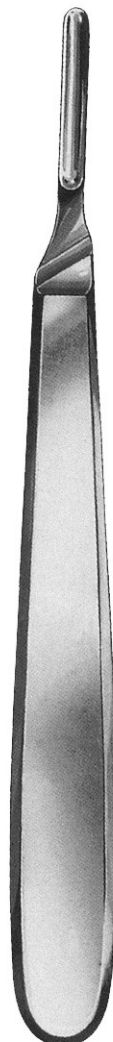

211-0009  
No.10



211-0010  
No.9



211-0011  
No. 3



211-0012  
BARRON  
For "B.P." type blades  
for use with No's  
10,11,12 & 15 blades  
135mm (5.1/4")



●●● HANDLES REFERENCE GUIDE



211-0013  
Single ended  
Knurling round



211-0014  
Double ended  
Knurling round

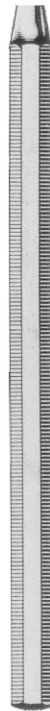

211-0015  
Single ended  
octangle serrated

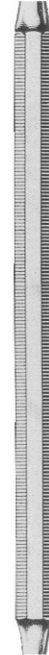

211-0016  
Double ended  
octangle serrated



211-0017  
Single ended  
hollow round



211-0018  
Double ended  
hollow round



211-0019  
Double ended  
hollow round grooved



211-0020  
Double ended  
swiss pattern octangle

**MICRO, NEEDLE HOLDERS** ●●●



212-0001  
CASTROVIEJO  
145mm (5.3/4")  
With catch



212-0002  
CASTROVIEJO  
145mm (5.3/4")  
With catch



212-0003  
ARRUGA  
135mm (5.1/4")



212-0004  
BARRAQUER  
120mm (4.3/4")  
With catch



212-0005  
BARRAQUER  
120mm (4.3/4")  
Without catch

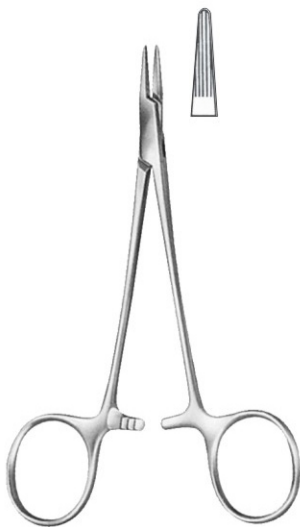

212-0006  
CONVERSE  
125mm (5")



212-0007  
DERF  
120mm (4.3/4")



212-0008  
MAYO (DUNHILL)  
160mm (6.1/4")



212-0009  
MAYO  
180mm (7")

●●● NEEDLE HOLDERS



212-0010  
MAYO  
190mm (7.1/2")



212-0011  
CRILE WOOD  
150mm (6")



212-0012  
CRILE MURRAY  
145mm (5.3/4")



212-0013  
KILNER  
135mm (5.1/4")



212-0014  
190mm (7.1/2")  
212-0015  
250mm (10")

NAUNTON MORGAN

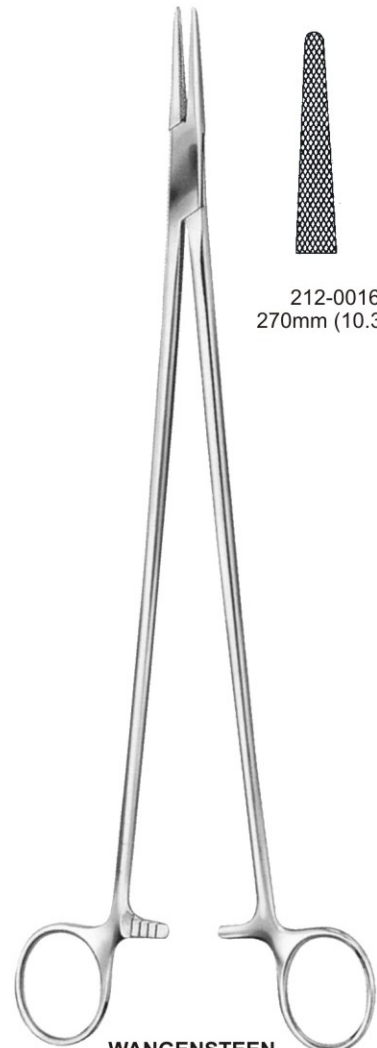

212-0016  
270mm (10.3/4")

WANGENSTEEN



**NEEDLE HOLDERS ●●●**

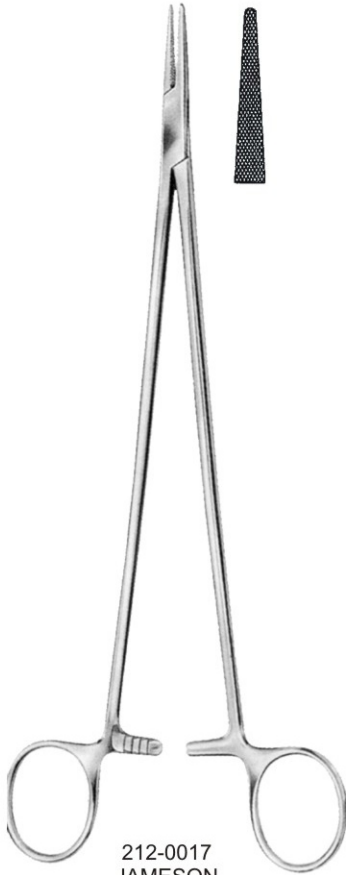

212-0017  
JAMESON  
230mm (9")



212-0018  
WRIGHT  
125mm (5")



212-0019  
GILLIES  
Combined needle holder  
and scissors  
160mm (6.1/4")

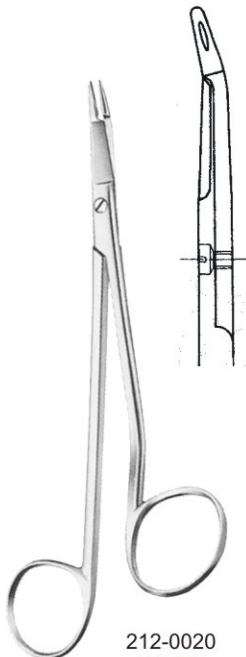

212-0020  
WARD  
Combined needle holder  
and scissors  
180mm (7")



212-0021  
HEANEY  
200mm (8")

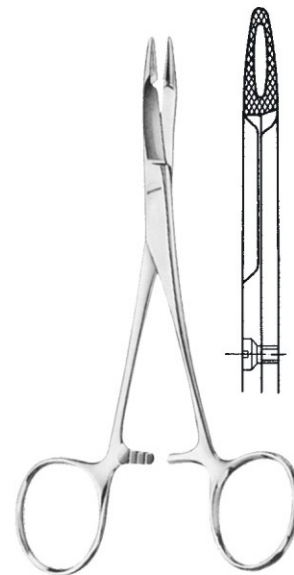

OLSEN HEGAR  
Combined needle holder  
and scissors  
212-0022 140mm (5.1/2")  
212-0023 165mm (6.1/2")  
212-0024 190mm (7.1/2")

●●● NEEDLE HOLDERS

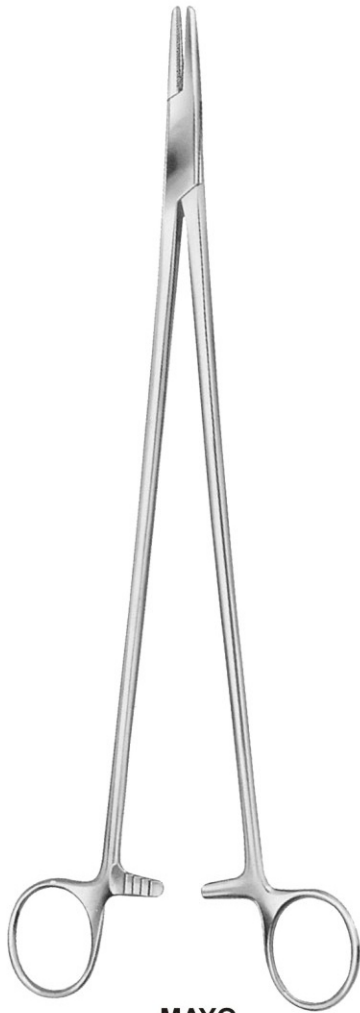

**MAYO**



212-0025  
MAYO (BAUMGARTNER)  
140mm (5.1/2")



212-0026  
MAYO (MASSON)  
265mm (10.1/2")



212-0027  
MAYO  
65mm (6.1/2")



212-0028  
190mm (7.1/2")



212-0029  
200mm (8")



212-0030  
230mm (9")



212-0031  
HEGAR  
200mm (8")



212-0032  
HALSEY  
125mm (5")



212-0033  
MATHIEU  
140mm (5.1/2")

NEEDLE HOLDERS ●●●



212-0034  
MATHIEU  
170mm (6.3/4")



212-0035  
MATHIEU  
200mm (8")



212-0036  
WEBSTER  
Smooth Jaw  
115mm (4.1/2")



212-0037  
MAYO  
150mm (6")

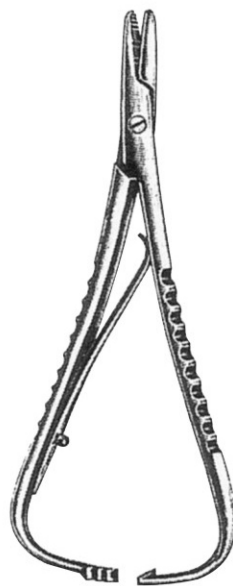

212-0038  
MCPHAILS  
180mm (7")



LAWRANCE  
212-0039 150mm (6")  
Lightweight  
212-0040 150mm (6")



●●● MOUTH MIRRORS



212-0041  
Plane -4



212-0042  
Plane -5



212-0043  
Magnifying-4

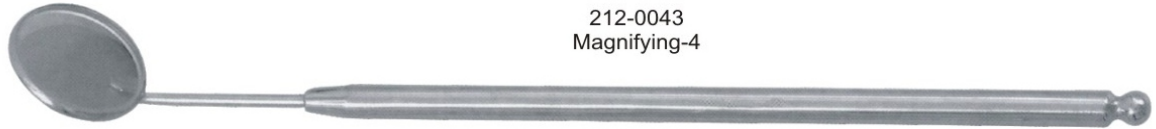

212-0044  
Magnifying-5



212-0045  
Front Surface-4



212-0046  
Front Surface-5



212-0047



212-0048  
Hollow



212-0049  
Hollow



212-0050  
Hollow

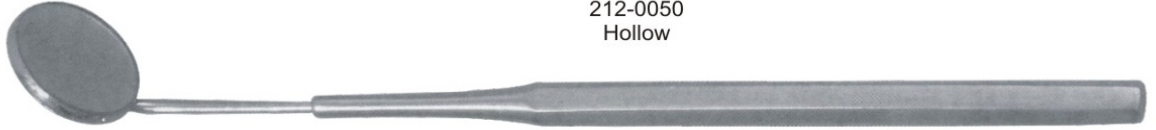

212-0051  
Hollow



212-0052  
Hollow

**EXPLORERS** ENDODONTIC INSTRUMENTS ●●●



213-0001  
Fig. 23



213-0002  
Fig. 2



213-0003  
Fig. 16



213-0004  
Fig. 9



213-0005  
Fig. 10



213-0006  
Fig. 12



213-0007  
Fig. 11



213-0008  
Fig. 6



213-0009  
Fig. 8



213-0010  
Fig. 5



213-0011  
Fig. 17



213-0012  
Fig. 17A



213-0013  
Fig. 3



213-0014  
Fig. 3A



213-0015  
Fig. 1  
Spreader



213-0016  
Fig. 2  
Spreader



213-0017  
Fig. 3  
Spreader



213-0018  
Fig. 4  
Spreader



213-0019  
Fig. 5  
Spreader



213-0020  
Fig. 6  
Spreader



213-0021  
Fig. 7  
Spreader

●●● **EXPLORERS** PROBES

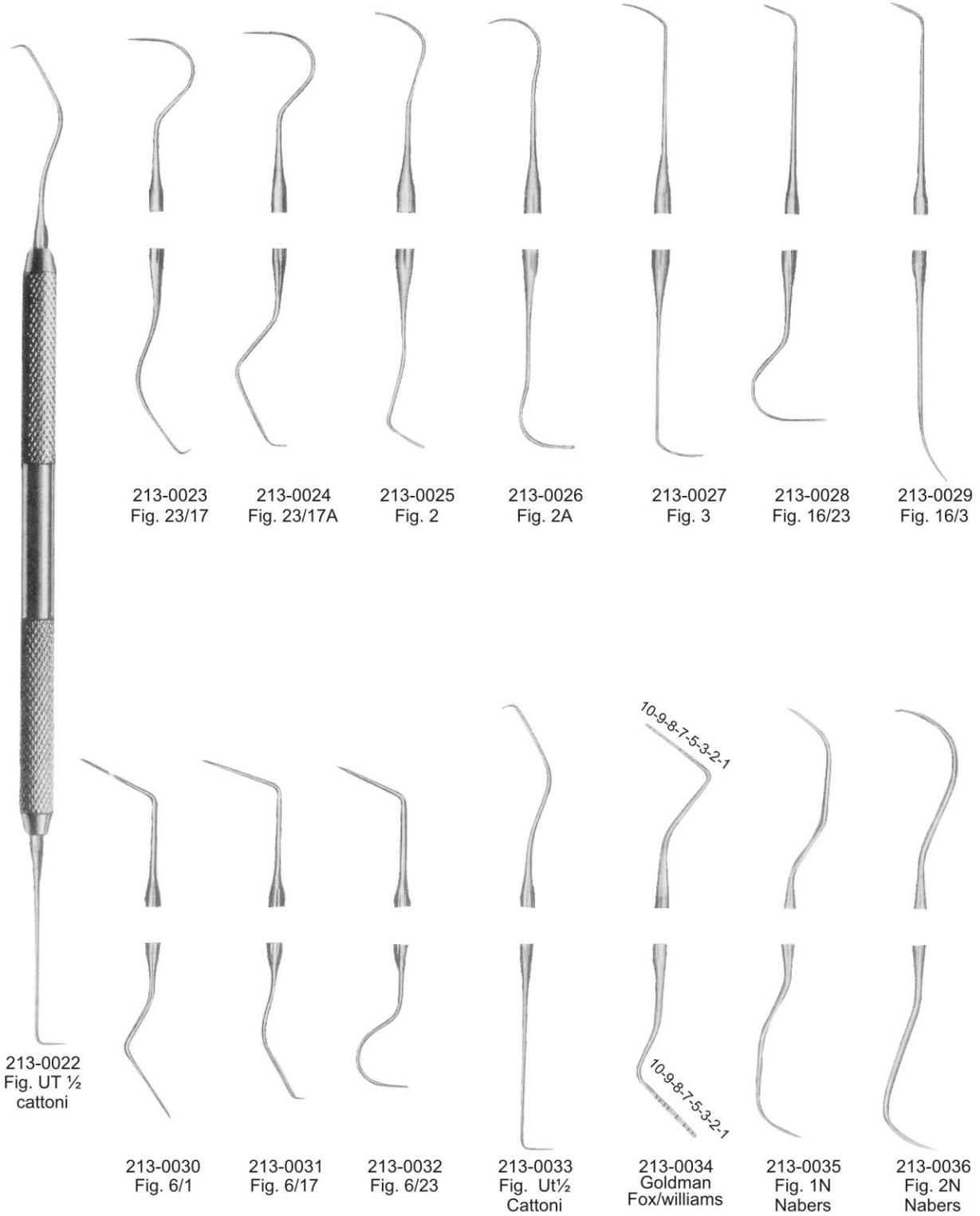

Root canal explorers

**EXPLORERS** ENDODONTIC INSTRUMENTS ●●●

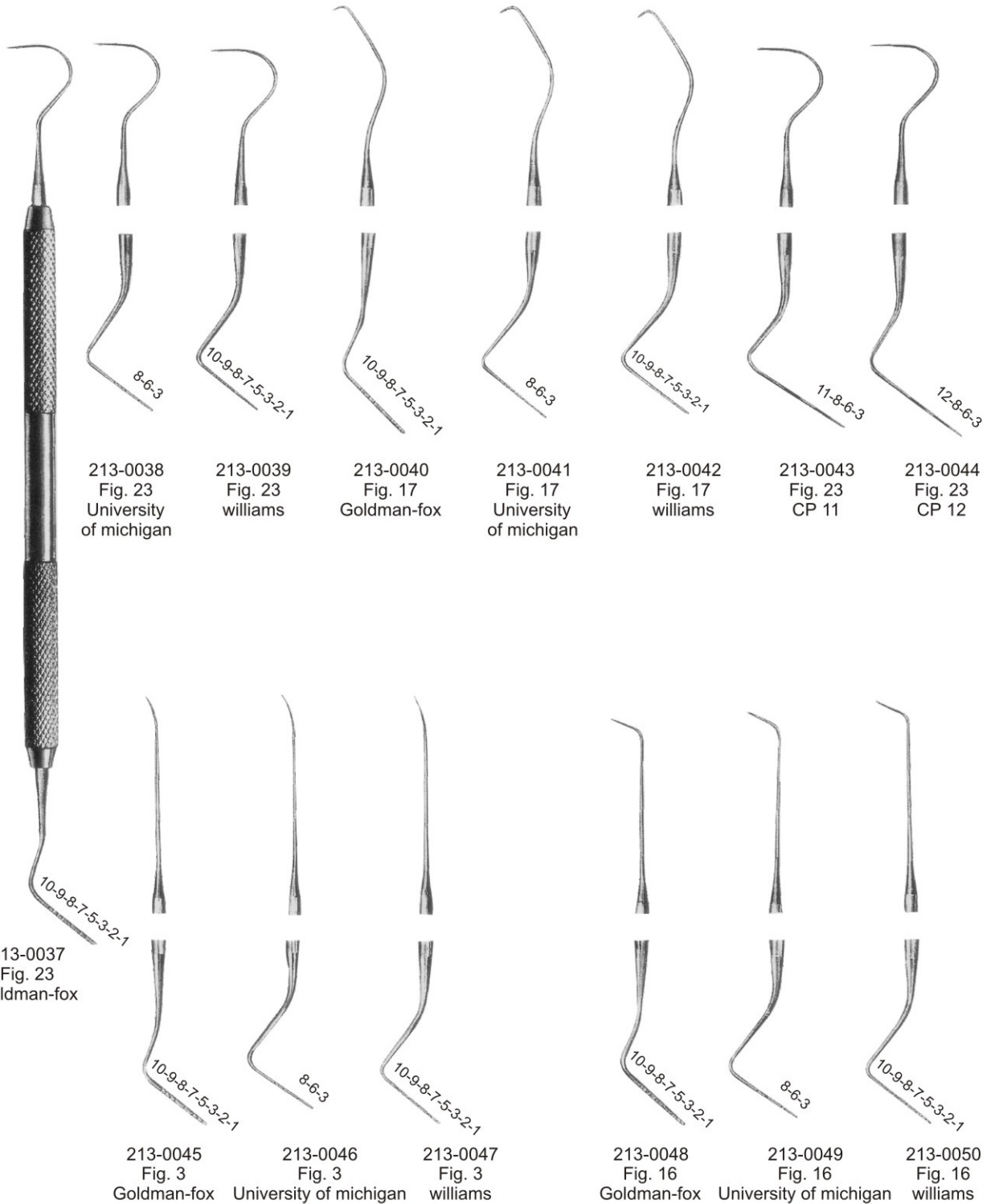





●●● PERIODONTAL POCKET PROBES ENDODONTIC INSTRUMENTS

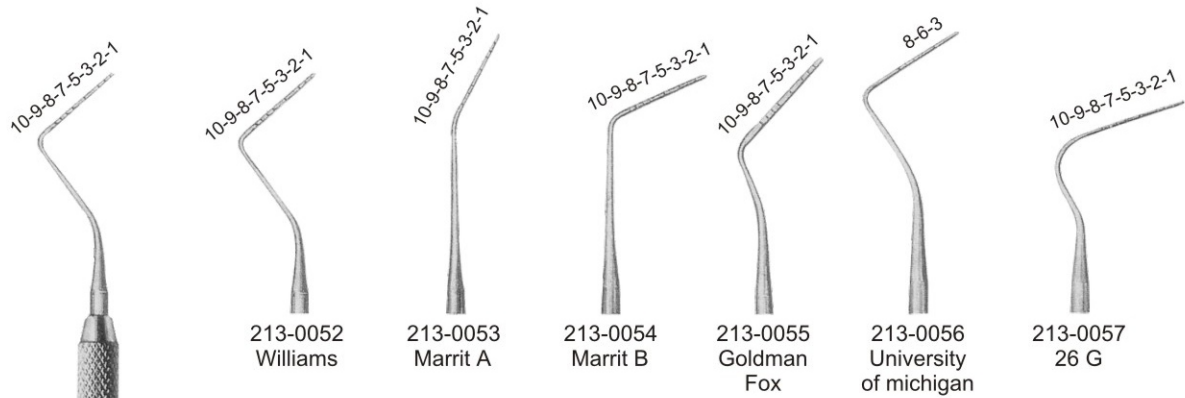

213-0051  
Williams

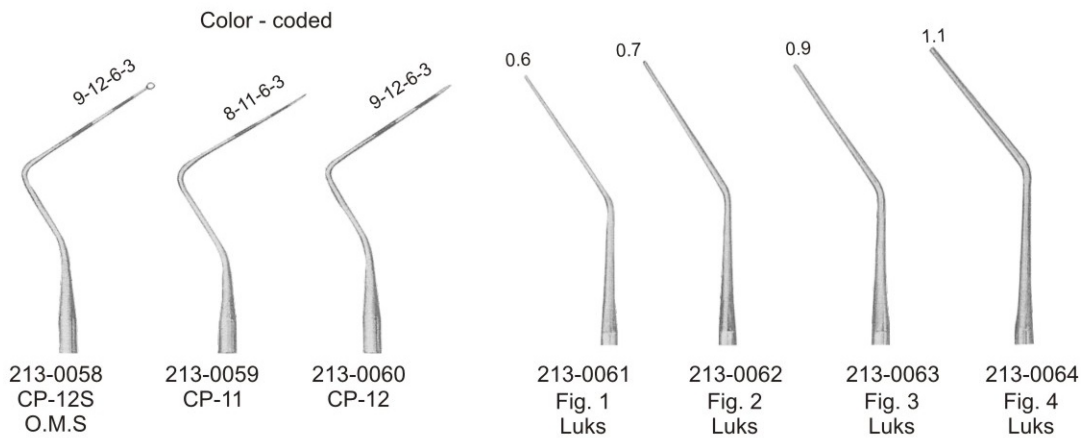

Root-canal pluggers

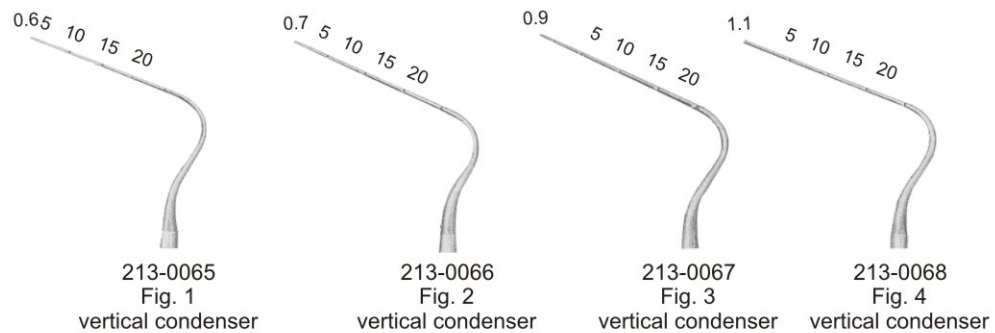

**FILLING INSTRUMENTS ●●●**

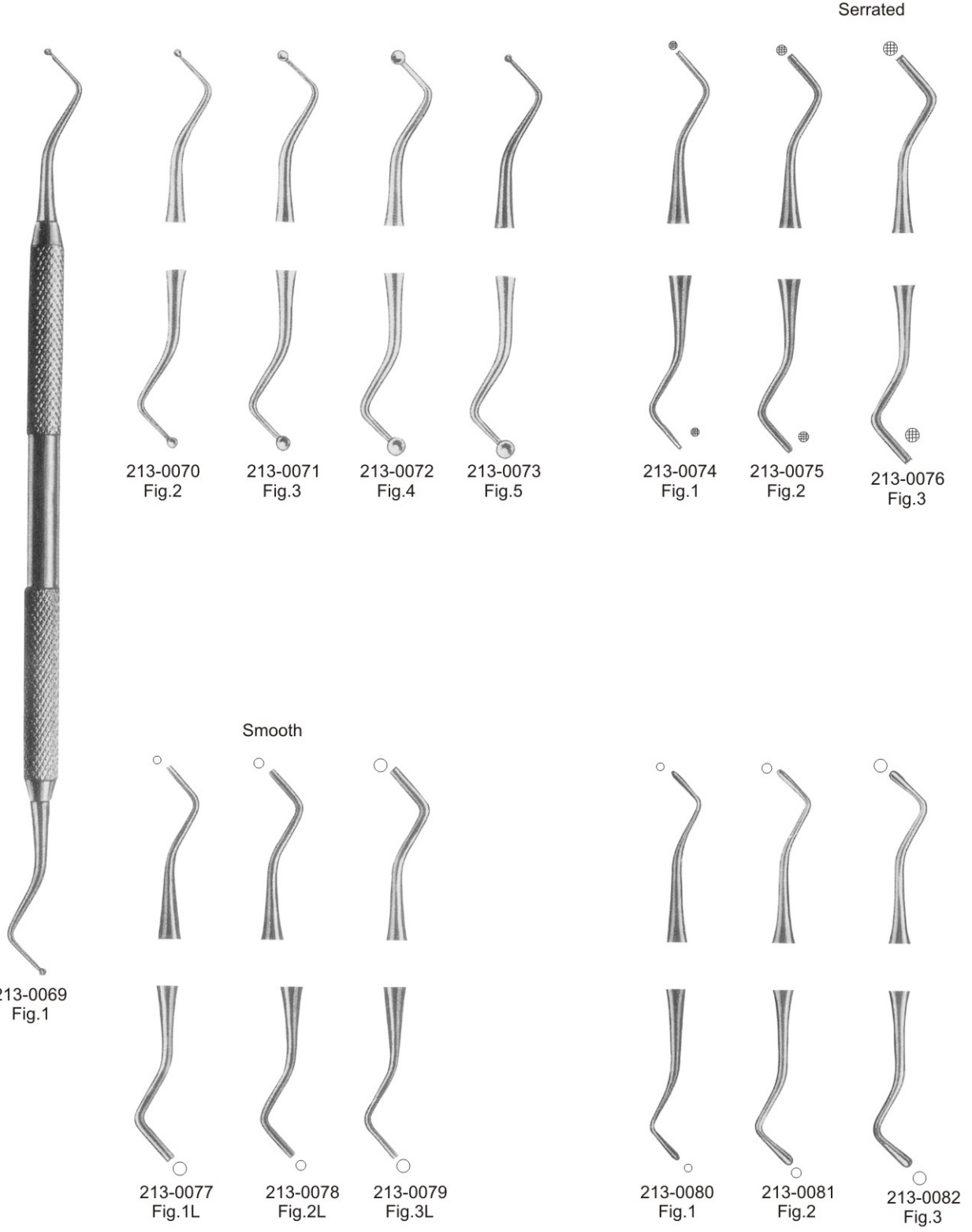

●●● FILLING INSTRUMENTS

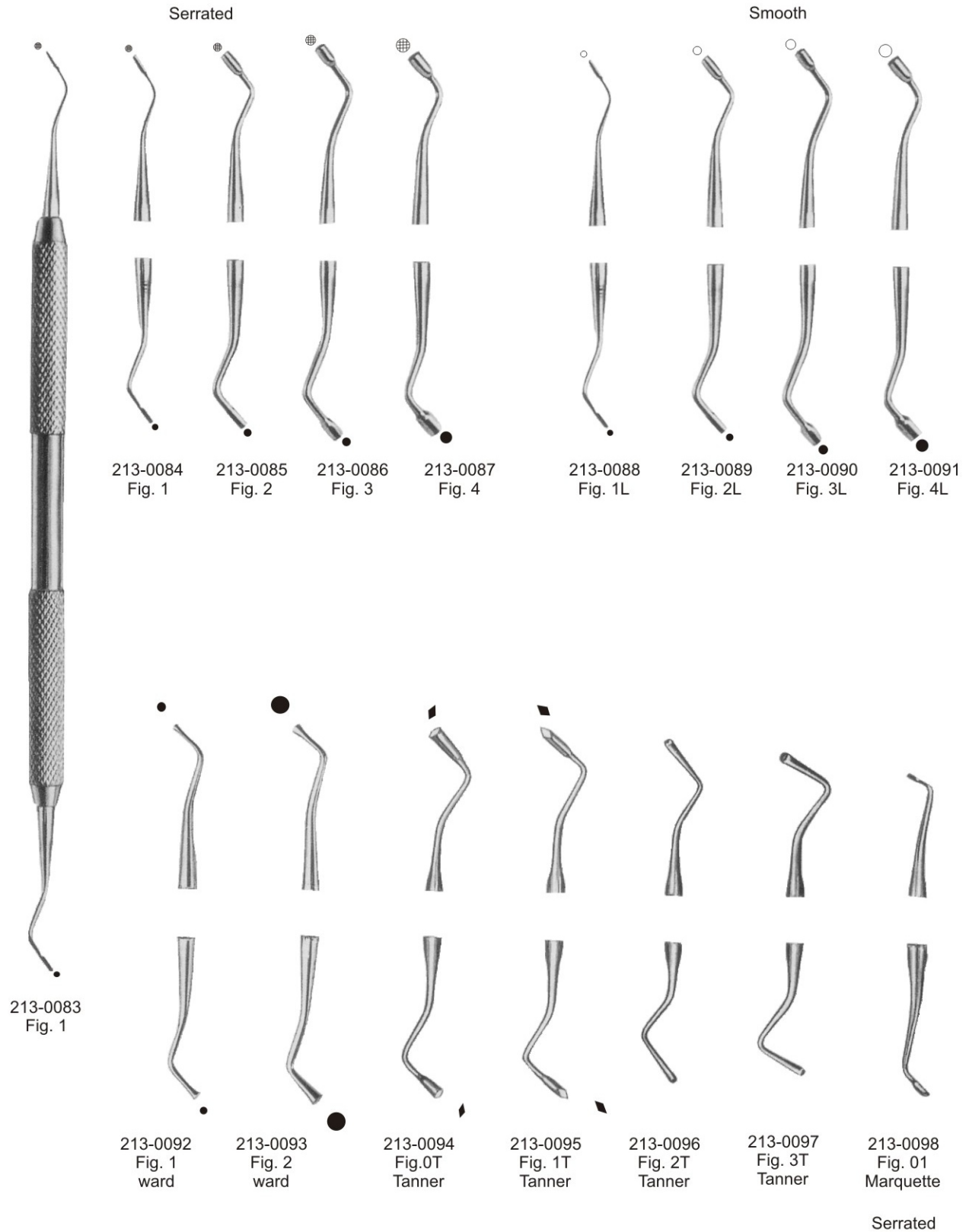

**FILLING INSTRUMENTS ●●●**

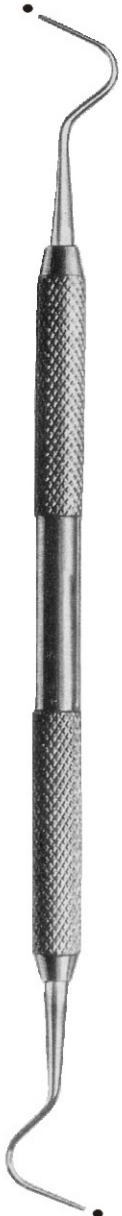

213-0099  
Fig. 1

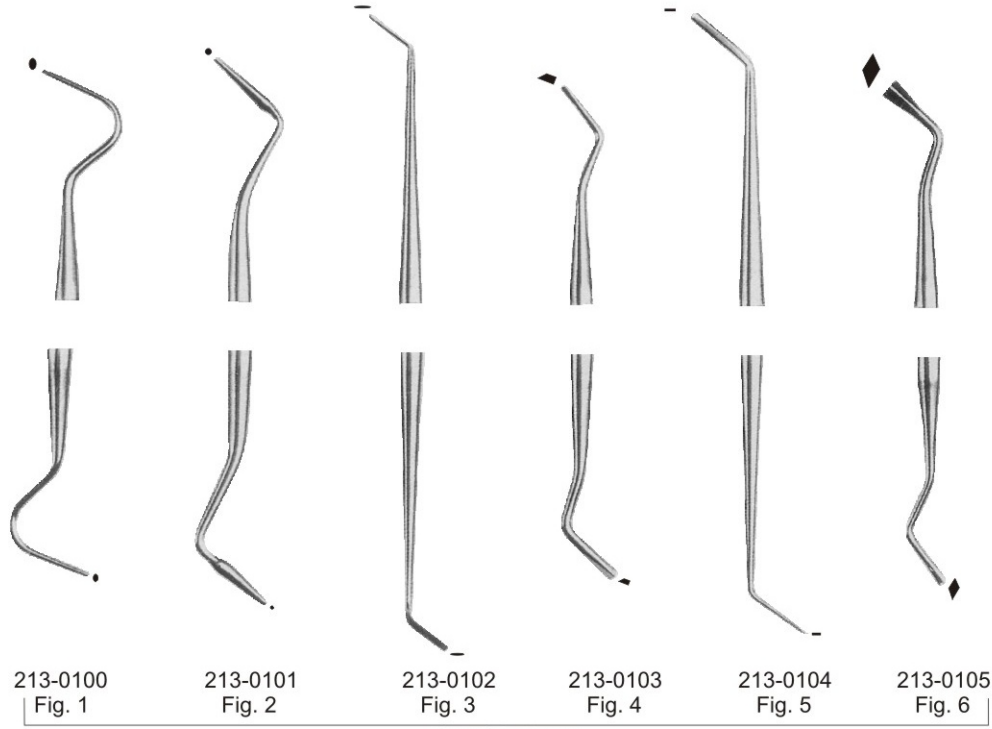

213-0100  
Fig. 1

213-0101  
Fig. 2

213-0102  
Fig. 3

213-0103  
Fig. 4

213-0104  
Fig. 5

213-0105  
Fig. 6

Set of 6 pieces

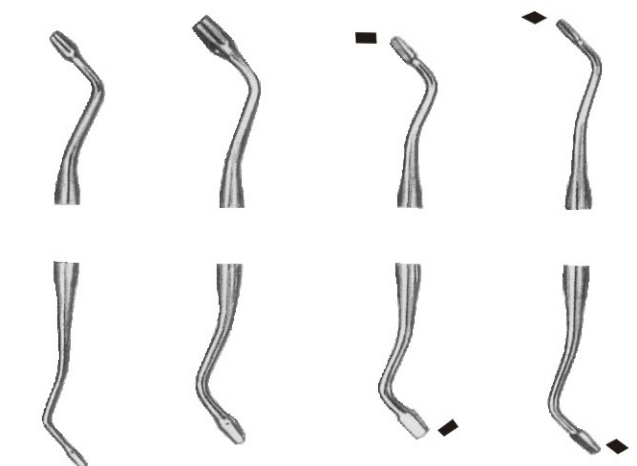

213-0106  
Fig. H1  
Hollenback

213-0107  
Fig. H2  
Hollenback

213-0108  
Fig. H3  
Hollenback

213-0109  
Fig. H4  
Hollenback



●●● **FILLING INSTRUMENTS** PLASTIC FILLING INSTRUMENTS

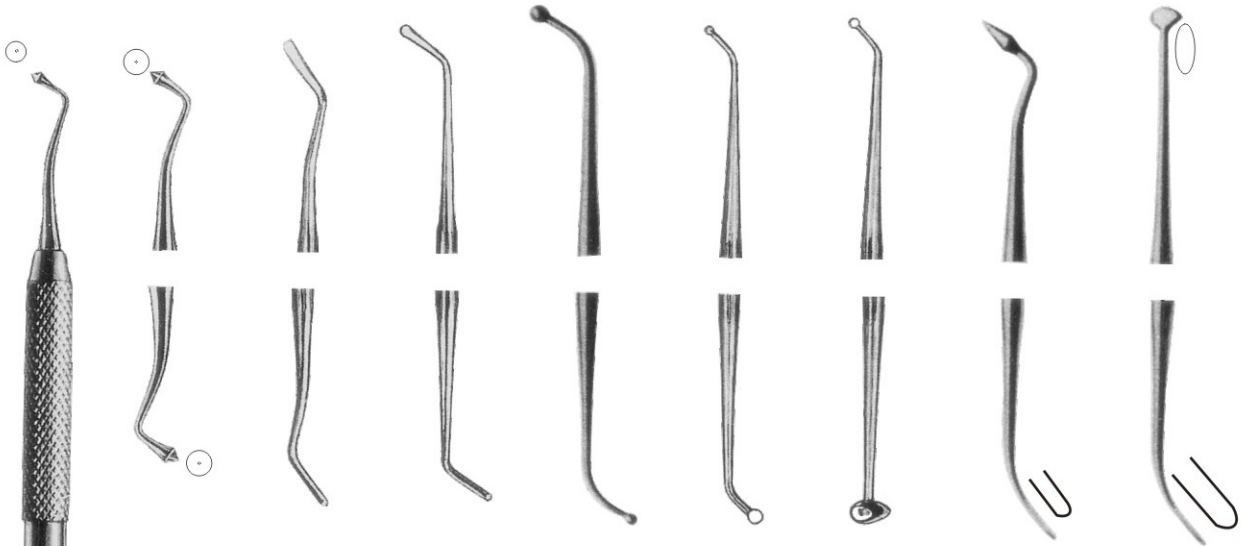

213-0111  
Fig. 2  
westcott

213-0112  
Fig. 2  
Ladmore

213-0113  
Fig. 3  
Ladmore

213-0114  
Fig. 18  
Ball

213-0115  
Fig. 26-27S  
Ball

213-0116  
Fig. 27-29  
Ball

213-0117  
Fig. NYU/B2

213-0118  
Fig. 2/31



213-0110  
Fig. 1  
westcott

Plastic Filling Instruments

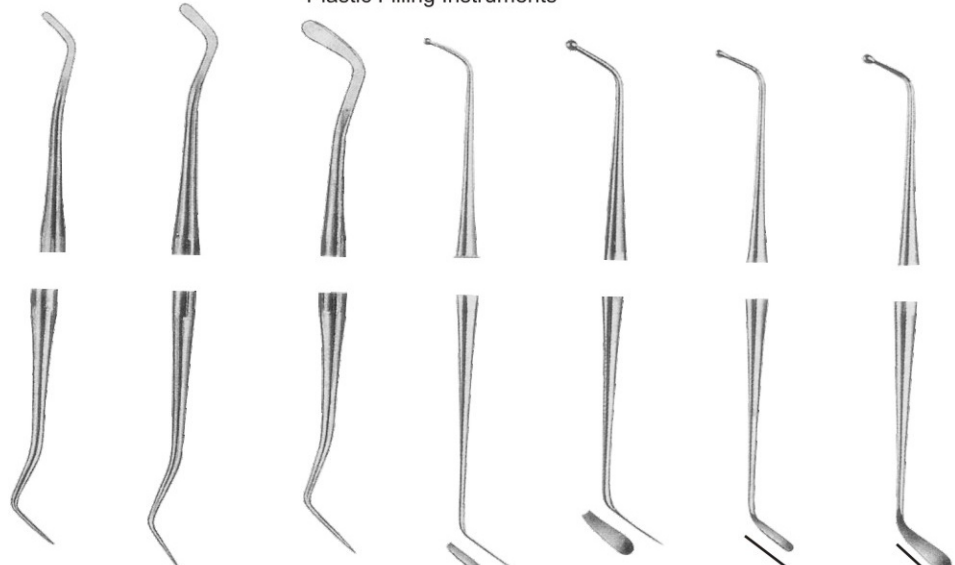

213-0119  
Fig. 1

213-0120  
Fig. 2

213-0121  
Fig. 3

213-0122  
Fig. 1

213-0123  
Fig. 2

213-0124  
Fig. 1

213-0125  
Fig. 2

**PLASTIC FILLING INSTRUMENTS AMALGAM CARVERS** ●●●

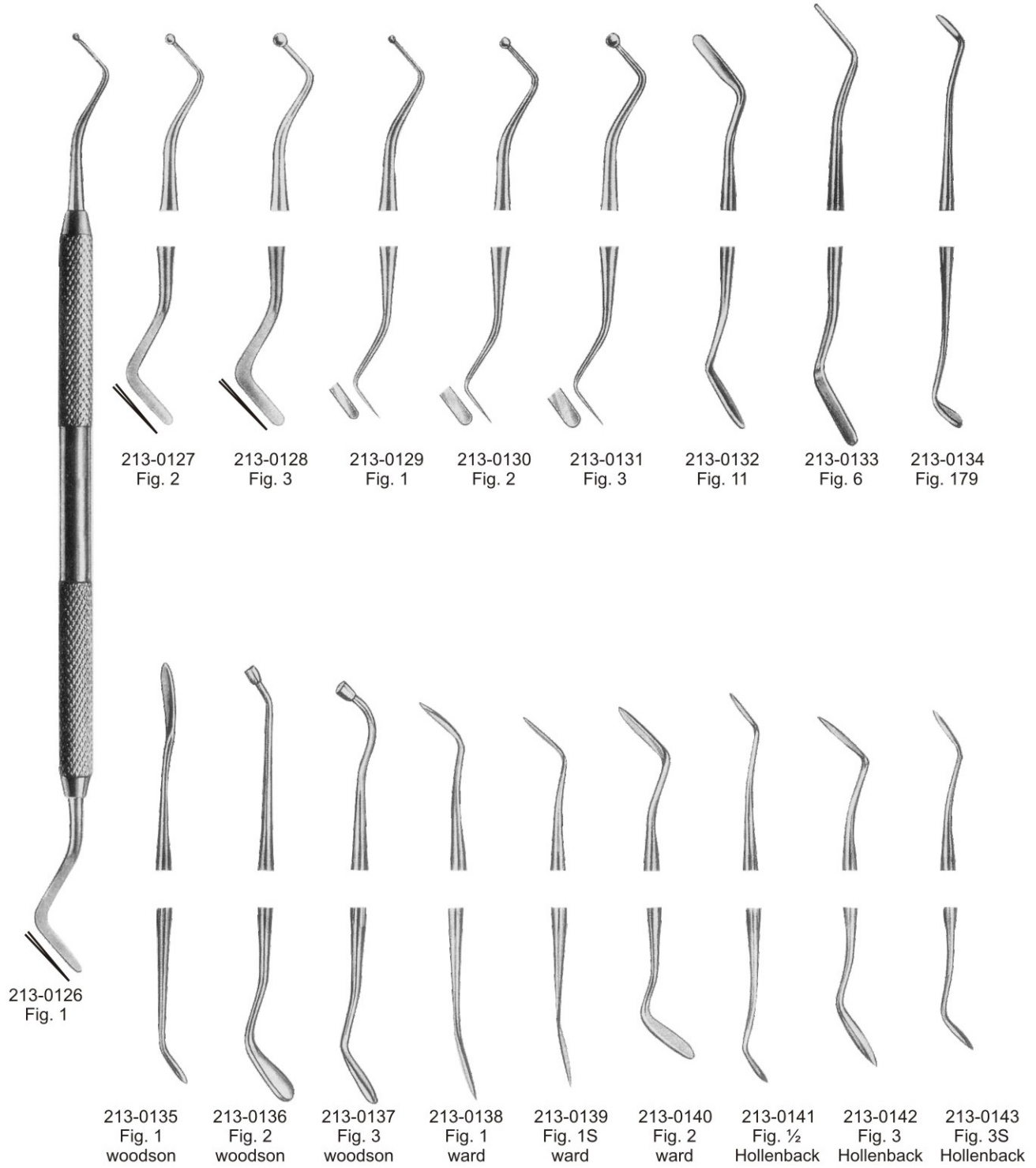

●●● **AMALGAM CARVERS** OPERATIVE INSTRUMENTS



213-0144  
Fig. 1  
farhim

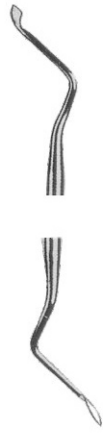

213-0145  
Fig. 2  
USC



213-0146  
Fig. 1  
interproximal

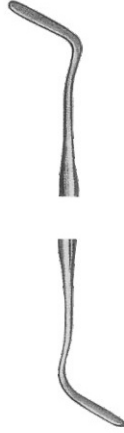

213-0147  
Fig. 2  
interproximal  
Off-Angle



213-0148  
Fig. SHO-A

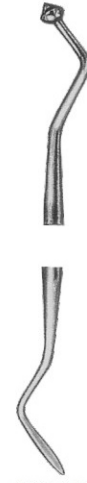

213-0149  
Fig. 3-SHO



213-0150  
Fig. 104



213-0151  
Fig. 8  
wiland

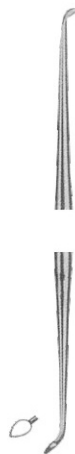

213-0152  
Fig. 1

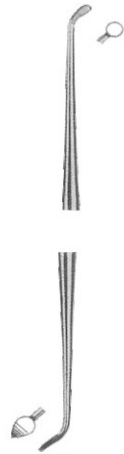

213-0153  
Fig. 2

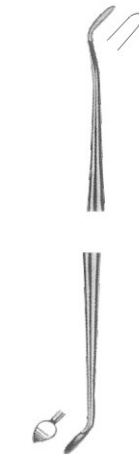

213-0154  
Fig. 3

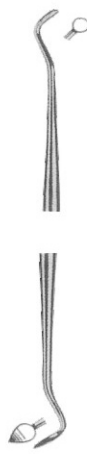

213-0155  
Fig. 4



213-0156

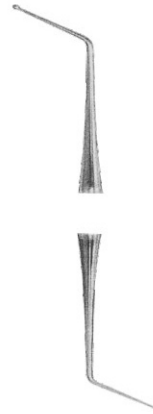

213-0157



213-0158

**CAVITY PREPARATION INSTRUMENTS ●●●**



213-0159  
Fig. 1  
Black/26

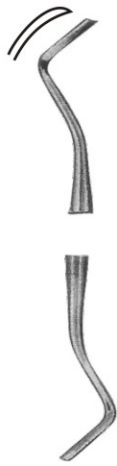

213-0160  
Fig. 2  
Black/27

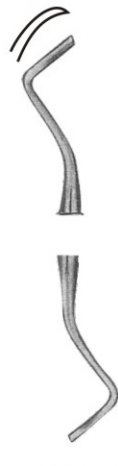

213-0161  
Fig. 3  
Black/28

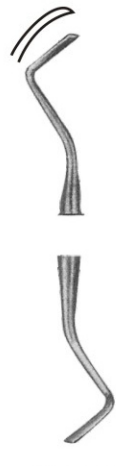

213-0162  
Fig. 4  
Black/29

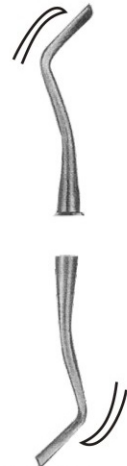

213-0163  
Fig. 1  
Black/77-78



213-0164  
Fig. 2  
Black/79-80



213-0165  
Fig. 1  
Black/53-54



213-0166  
Fig. 2  
Black/51-52



213-0167  
Fig. 1/2  
Wedelstaet



213-0168  
Fig. 3/4  
Wedelstaet



213-0169  
Fig. 5/6  
Wedelstaet



213-0170  
Fig. 1/2  
TG Chisel



213-0171  
Fig. H6-H7  
Hollow Handle



●●● EXCAVATORS



213-0172  
Fig. 6



213-0173  
Fig. 14



213-0174  
Fig. 18



213-0175  
Fig. 17W  
Oval Spoon



213-0176  
Fig. 17



213-0177  
Fig. 18W  
Oval Spoon



213-0178  
Fig. 19



213-0179  
Fig. 19W  
Oval Spoon



Set of 5 Pieces



213-0180  
Fig. 0



213-0181  
Fig. 1



213-0182  
Fig. 2



213-0183  
Fig. 3



213-0184  
Fig. 4



213-0185  
Fig. 1



213-0186  
Fig. 2



**EXCAVATORS** ●●●



213-0187  
Fig. 38/39

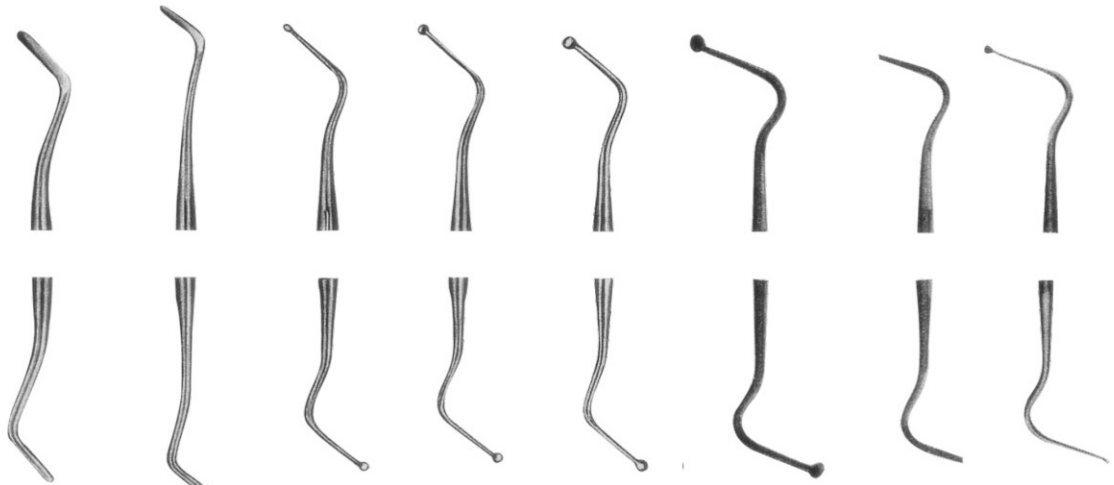

213-0188  
Fig. 63/64

213-0189  
Fig. 65/66

213-0190  
Fig. 31L

213-0191  
Fig. 32L

213-0192  
Fig. 33L

213-0193  
Fig. 135/136

213-0194  
Fig. 139/140

213-0195  
Fig. 141/142



213-0196  
Fig. 113/114

213-0197  
Fig. 115/116

213-0198  
Fig. 117/118

213-0199  
Fig. 119/120

213-0200  
Fig. 121/122

213-0201  
Fig. 123/124

213-0202  
Fig. 153/154

213-0203  
Fig. 155/156

213-0204  
Fig. 157/158

213-0205  
Fig. 159/160

●●● EXCAVATORS ENGLISH PATTERN

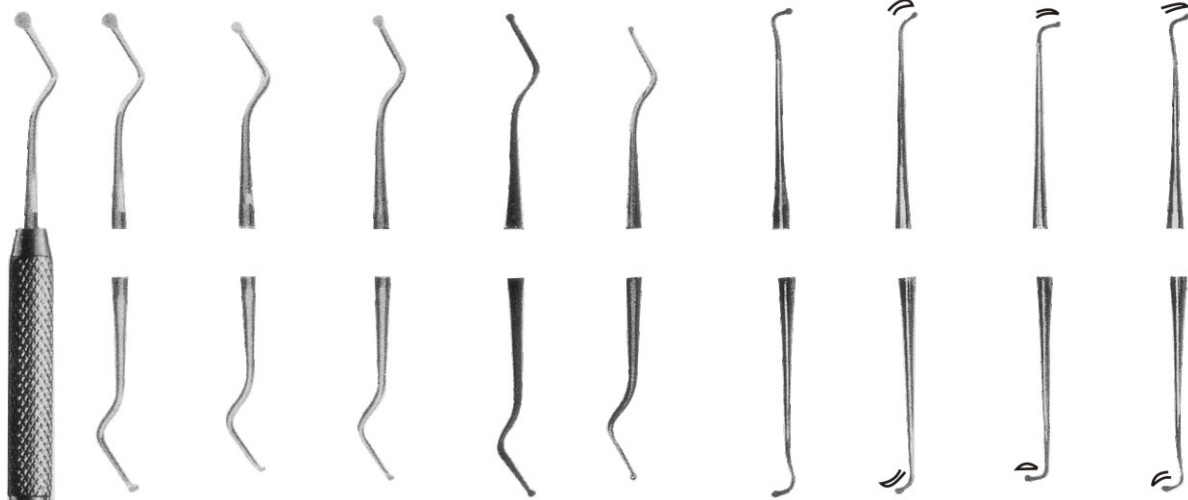

213-0207 Fig. 125/126    213-0208 Fig. 127/128    213-0209 Fig. 129/130    213-0210 Fig. 131/132    213-0211 Fig. 133/134    213-0212 Fig. 9/10    213-0213 Fig. 204/205    213-0214 Fig. 206/207    213-0215 Fig. 208/209



213-0206  
Fig. 125/126

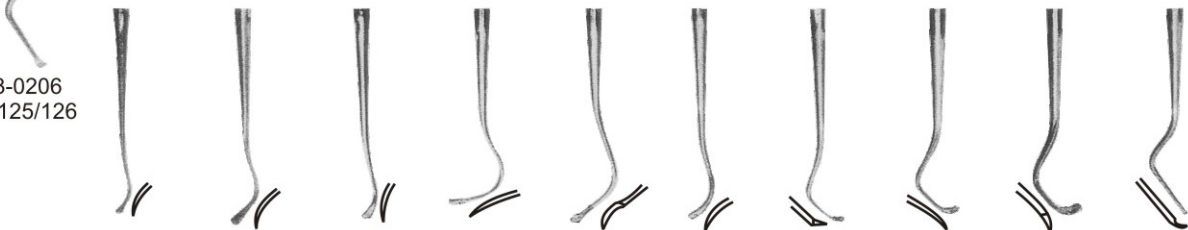

213-0216 Fig. 210/211    213-0217 Fig. 212/213    213-0218 Fig. 214/215    213-0219 Fig. 216/217    213-0220 Fig. 218/219    213-0221 Fig. 220/221    213-0222 Fig. 243    213-0223 Fig. 244    213-0224 Fig. 245    213-0225 Fig. 246

**PERIODONTIA INSTRUMENTS ●●●**



213-0226  
Fig. M9  
Molt

213-0227  
Fig. 1  
Hopkins

213-0228  
Fig. 2  
Hopkins

213-0229  
Fig. 3  
Mead

213-0230  
Fig. 3  
Prichard

213-0231  
Fig. Pr3  
Freer

213-0232  
Fig. 16  
Freer



● ● ● BONE FILES

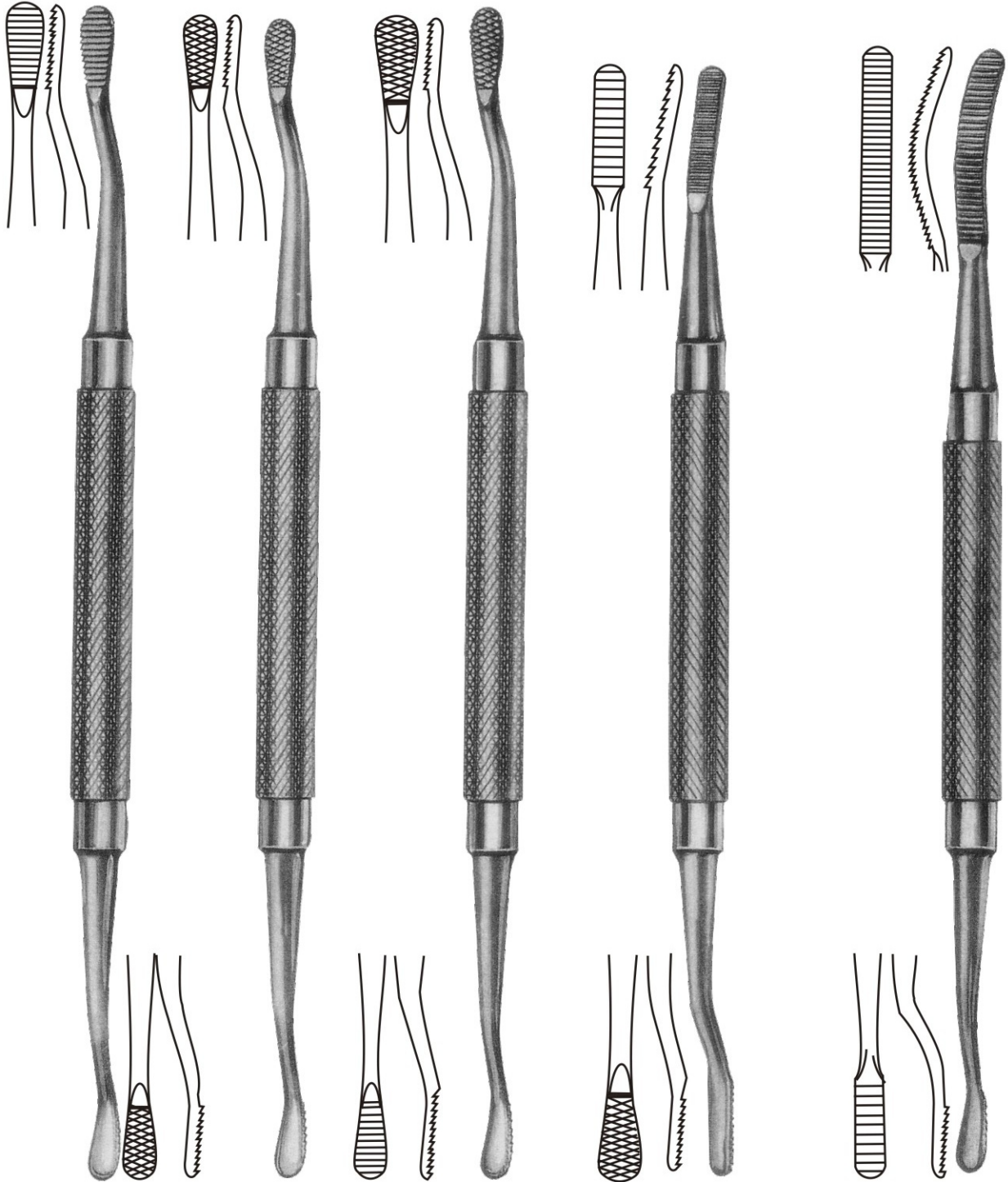

213-0233  
Fig. 12 CA

213-0234  
Fig. 12A

213-0235  
Fig. 12  
Howard

213-0236  
Fig. 33

213-0237  
Fig. 45  
Miller



213-0238  
Fig. 1  
Wahl



213-0239  
Fig. 2  
Wahl

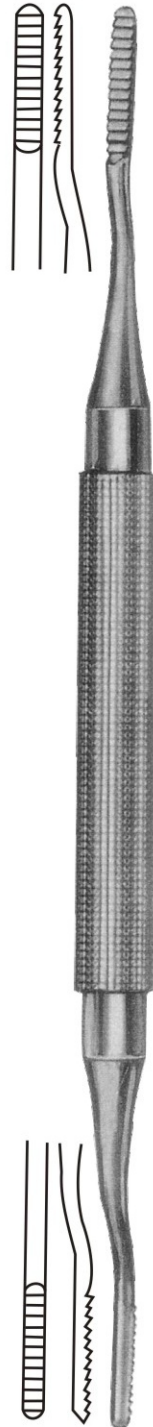

213-0240  
Fig. 1  
Polokoff

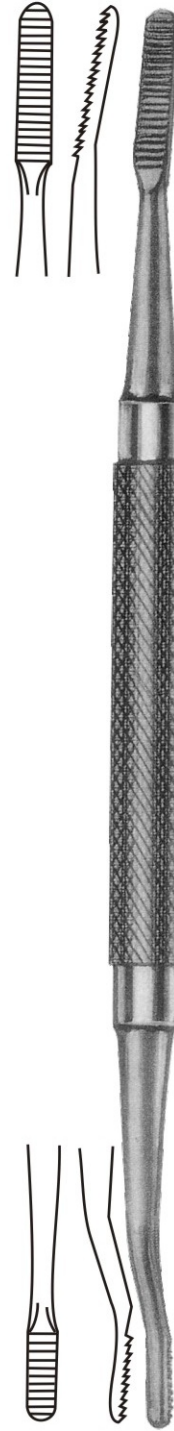

213-0241  
Fig. 64  
Miller

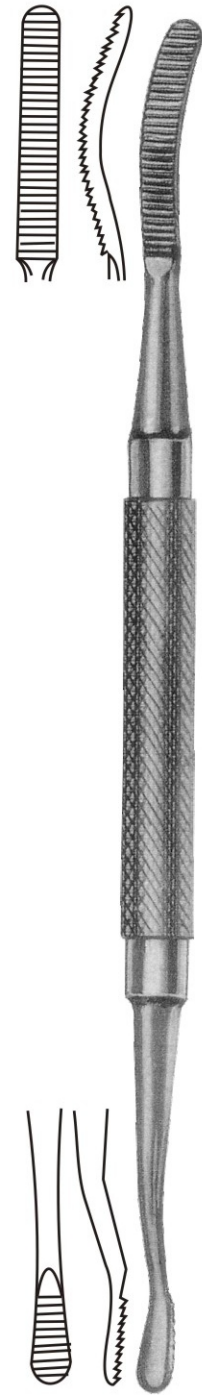

213-0242  
Fig. 10

●●● **BONE CURETTES** PERIODONTIA INSTRUMENTS

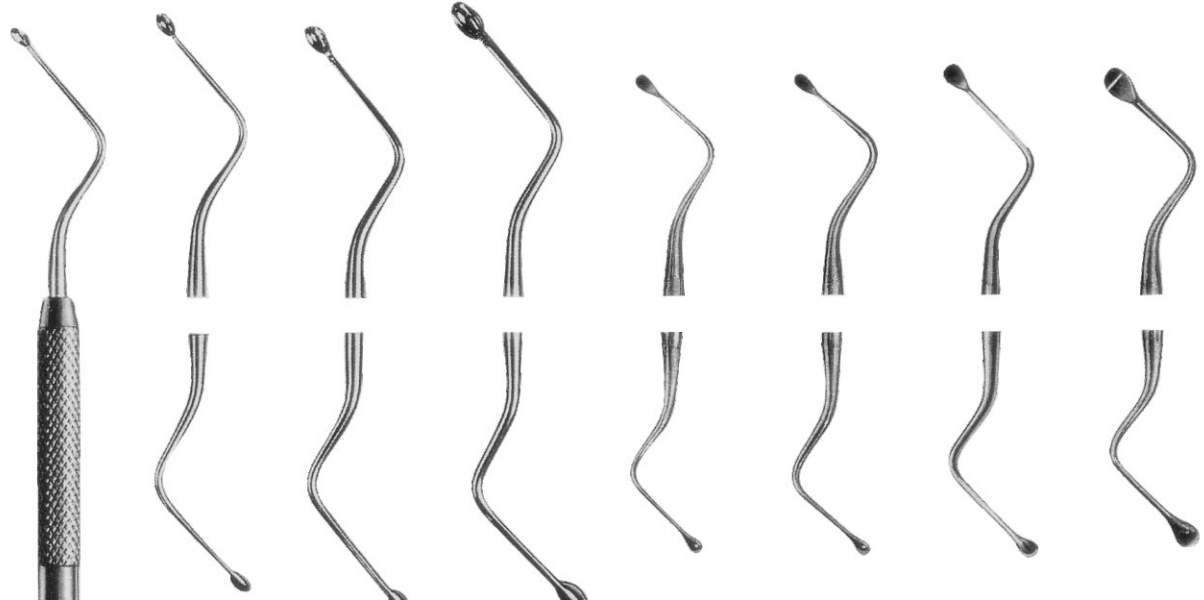

213-0244  
Fig. 2  
Hemingway

213-0245  
Fig. 3  
Hemingway

213-0246  
Fig. 4  
Hemingway

213-0247  
Fig. 85  
Lucas

213-0248  
Fig. 86  
Lucas

213-0249  
Fig. 87  
Lucas

213-0250  
Fig. 88  
Lucas

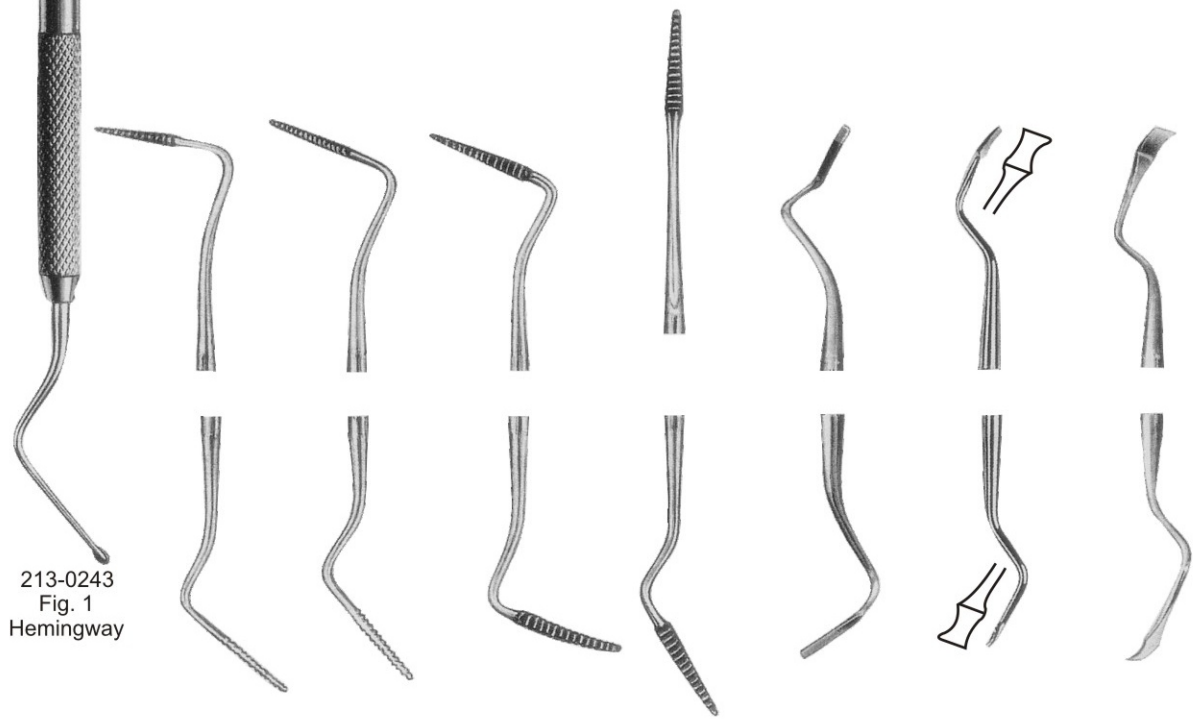

213-0243  
Fig. 1  
Hemingway

213-0251  
Fig. 1S/2S  
Sugarman

213-0252  
Fig. 3S/4S  
Sugarman

213-0253  
Fig. 9/10  
Schluger

213-0254  
Fig. 11/12  
Buck

213-0255  
Fig. 3  
Ochsenbein

213-0256  
Fig. 4  
Ochsenbein

213-0257  
Fig. 36/37  
Rhodes back-action

**PERIODONTIA INSTRUMENTS ●●●**



213-0258  
Fig. 7  
Goldman-fox

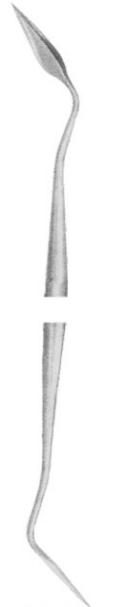

213-0259  
Fig. 8  
Goldman-fox

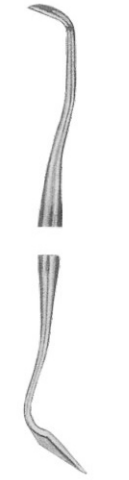

213-0260  
Fig. 9  
Goldman-fox

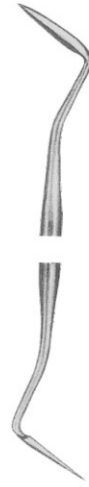

213-0261  
Fig. 11  
Goldman-fox



213-0262  
Fig. 3/4  
Buck

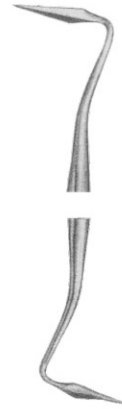

213-0263  
Fig. 5/6  
Buck



213-0264  
Fig. 1/2  
(15k16k)  
Kirkland

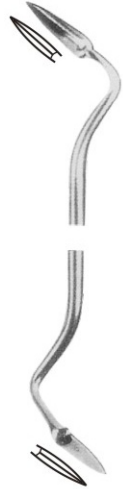

213-0265  
Fig. 1/2  
Orabin

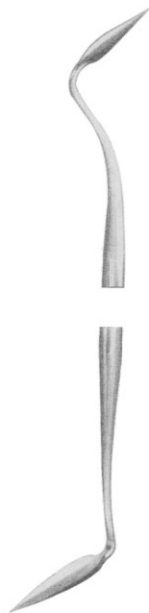

213-0266  
Fig. 1/2  
Sanders

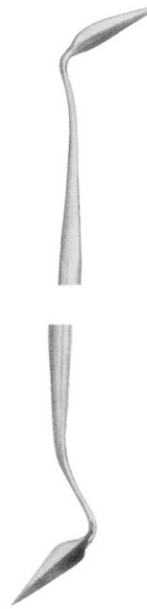

213-0267  
Fig. 4/5  
Sanders

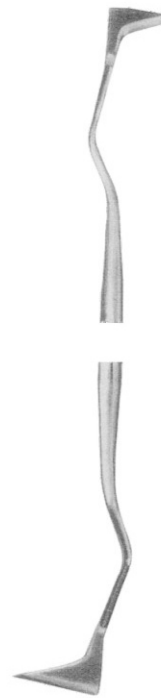

213-0268  
Fig. 19/20  
Sanders  
(University of South California)  
USC Towner

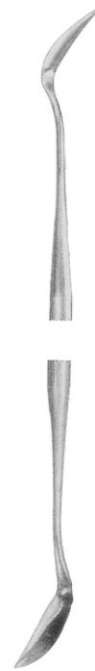

213-0269  
Fig. Ck3  
crane-kaplan



●●● PERIODONTIA INSTRUMENTS



213-0270  
Fig. HU ½  
Curette

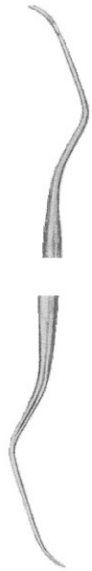

213-0271  
Fig. 2R/2L  
columbia



213-0272  
Fig. 4R/4L  
columbia



213-0273  
Fig. 13/14  
columbia

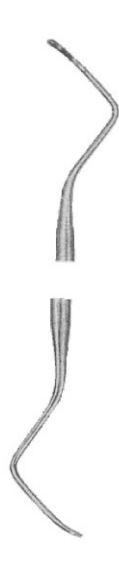

213-0274  
Fig. 414/412



213-0275  
Fig. 413/414



213-0276  
Fig. ½  
Langer



213-0277  
Fig. ¾  
Langer

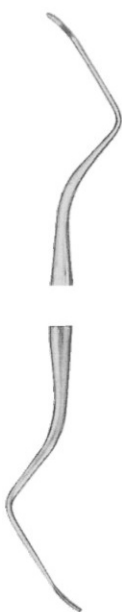

213-0278  
Fig. ½  
Barnhart

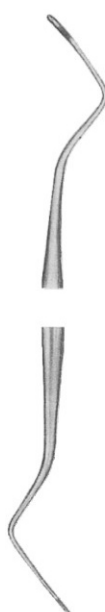

213-0279  
Fig. 5/6  
Barnhart

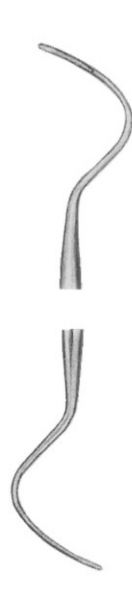

213-0280  
Fig. ME-1  
(10/11)

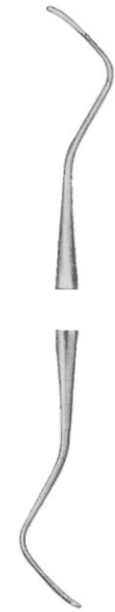

213-0281  
Fig. ¾  
Rule(13/24)



213-0282  
Fig. 11/14  
Gracey  
Mesial-Distal



213-0283  
Fig. 12/13  
Gracey  
Mesial-Distal

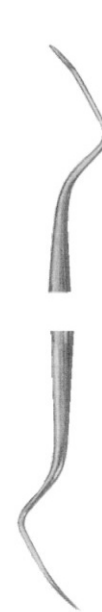

213-0284  
Fig. 13/14  
Indiana University  
Anterior



213-0285  
Fig. 17/18  
Indiana University  
Posterior

**PERIODONTIA INSTRUMENTS GRACEY CURETTES ●●●**

Set of 9 Pieces  
Set of 7 Pieces

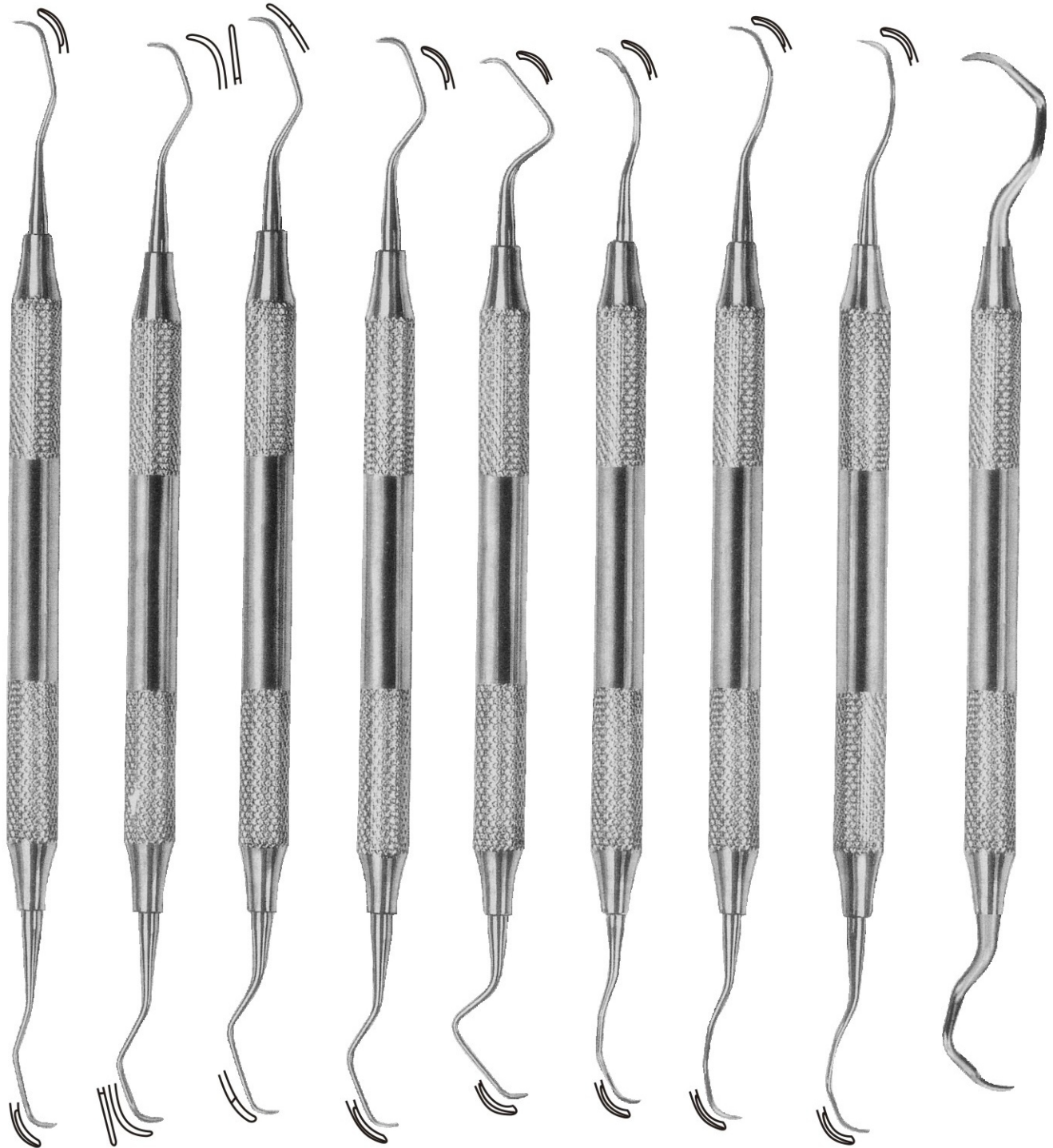

213-0286  
Fig. 1/2  
Gracey

213-0287  
Fig. 3/4  
Gracey

213-0288  
Fig. 5/6  
Gracey

213-0289  
Fig. 7/8  
Gracey

213-0290  
Fig. 9/10  
Gracey

213-0291  
Fig. 11/12  
Gracey

213-0292  
Fig. 13/14  
Gracey

213-0293  
Fig. 15/16  
Gracey

213-0294  
Fig. 17/18  
Gracey

●●● PERIODONTIA INSTRUMENTS

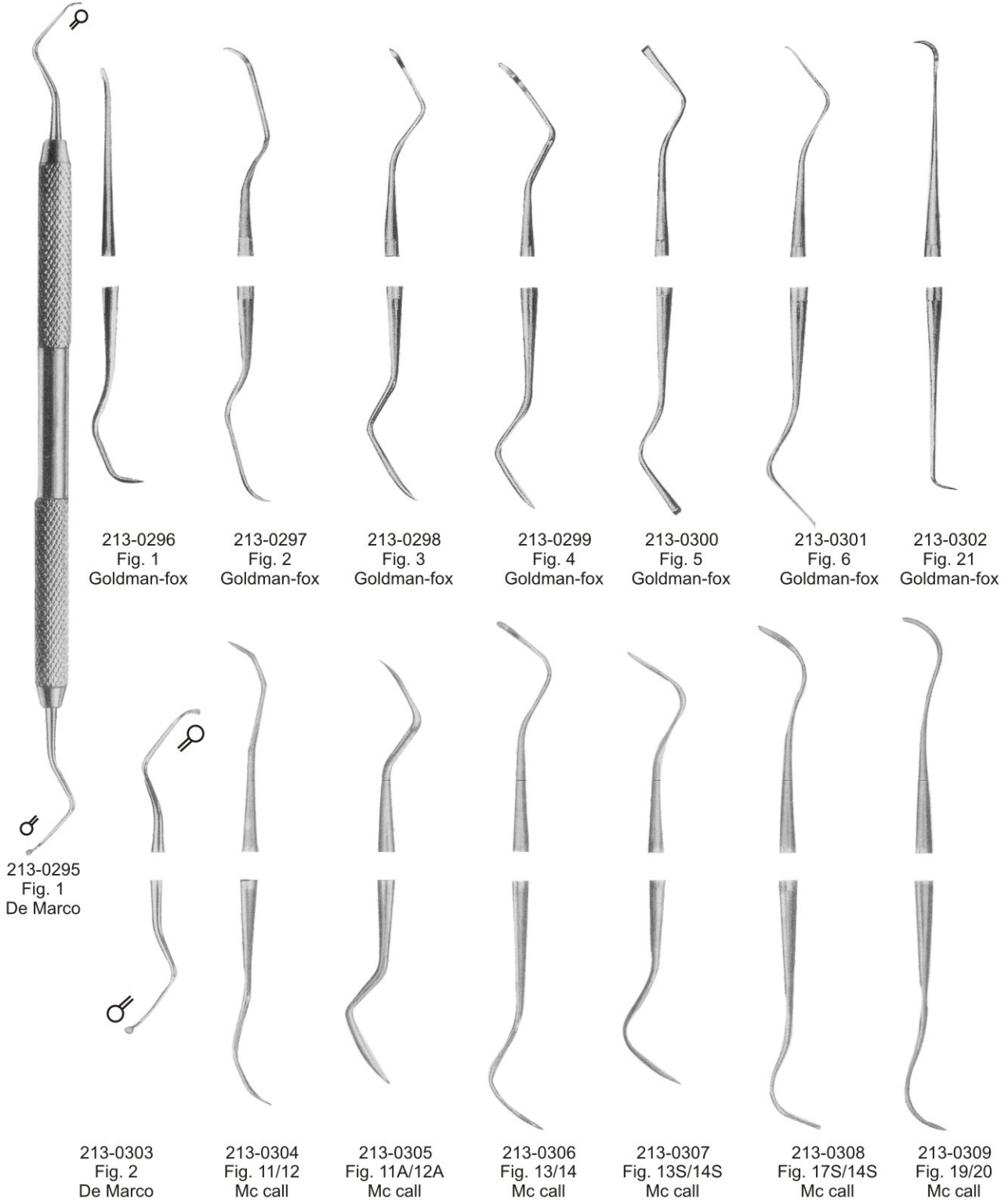

**PERIODONTIA INSTRUMENTS**

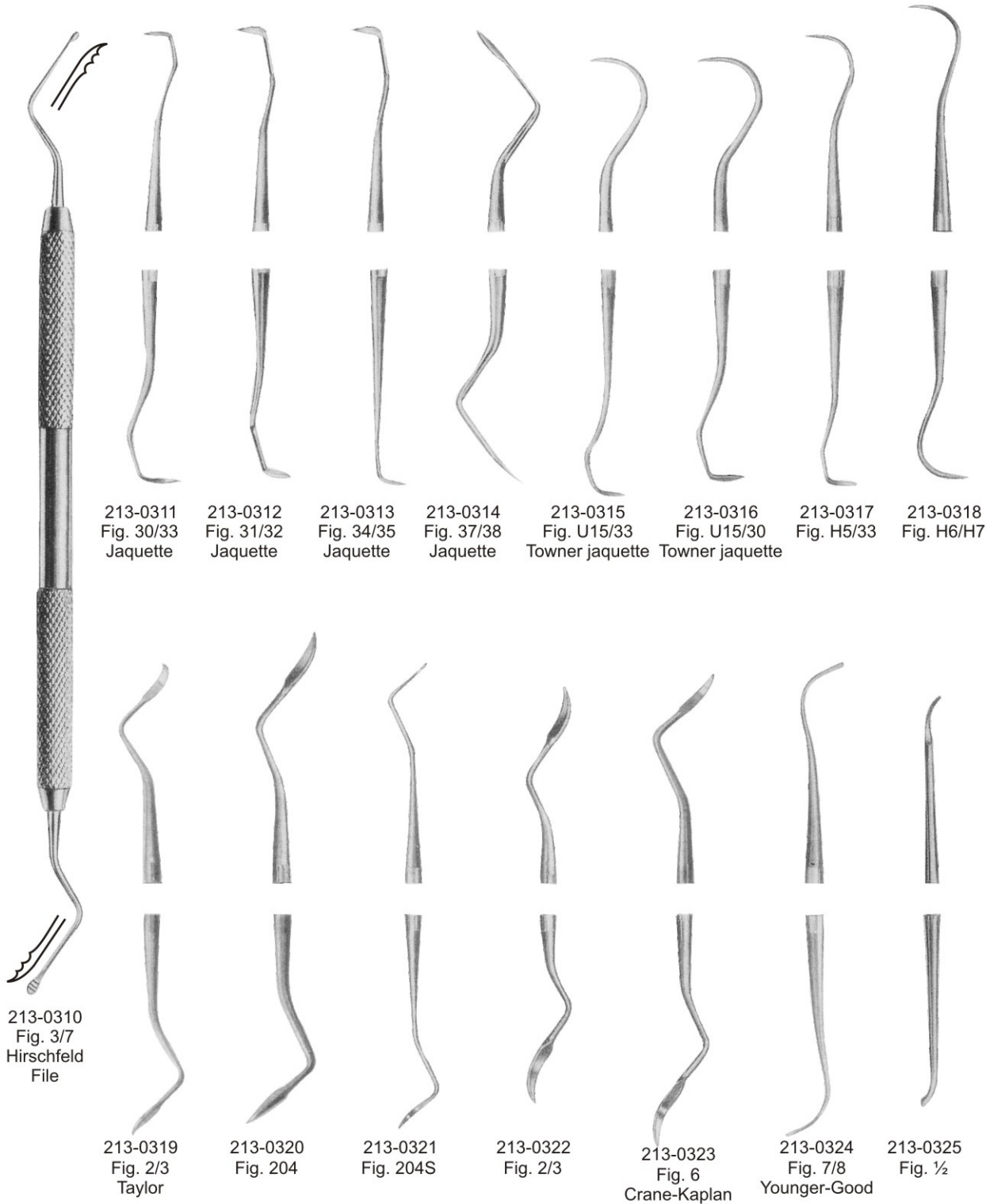



●●● PERIODONTIA INSTRUMENTS



213-0326  
Fig. 33



213-0327  
Fig. 31



213-0328  
Fig. 32



213-0329  
Fig. 34



213-0330  
Fig. 35



213-0331  
Fig. H5  
Hygienist



213-0332  
Fig. H6  
Hygienist



213-0333  
Fig. H7  
Hygienist



213-0334  
Fig. 1



213-0335  
Fig. 1L  
(Sinistro)



213-0336  
Fig. 1R  
(Destro)



213-0337  
Fig. 2L  
(Sinistro)



213-0338  
Fig. 2R  
(Destro)



213-0339  
Fig. U15  
Towner



213-0340  
Zetring-Chisel

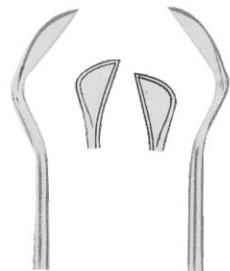

213-0341  
Fig. 1  
Kirkland



213-0342  
Fig. 2  
Kirkland



213-0343  
Fig. 1  
Orban



213-0344  
Fig. 2  
Orban



213-0345  
Fig. 1  
TG Chisel



213-0346  
Fig. 2  
TG Chisel

**CEMENT SPATULAS**



213-0347



213-0348

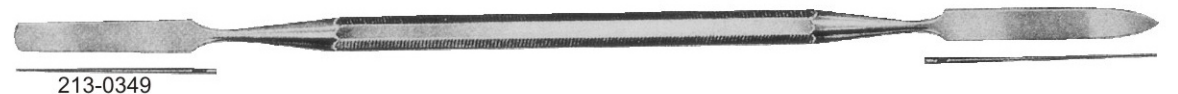

213-0349



213-0350



213-0351

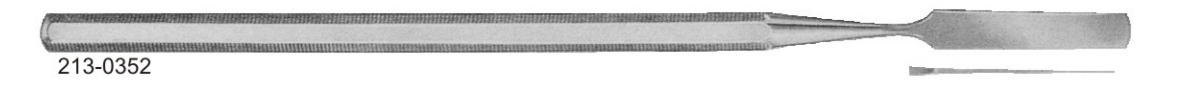

213-0352



213-0353



213-0354



213-0355  
Fig. 1

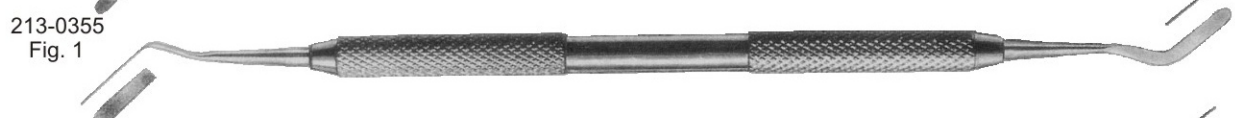

213-0356  
Fig. 2

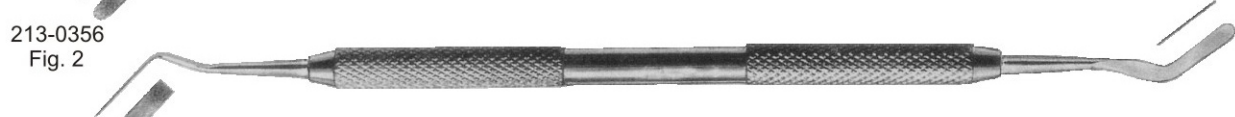

213-0357  
Fig. 3

●●● WEX AND MODELLING CARVERS



213-0358  
Zahle

213-0359  
Zahle

213-0360  
Zahle

213-0361  
Hylin

213-0362  
Hylin-Ceramica

213-0363  
Hylin-Sacred

213-0364  
Hylin-Le Cron

213-0365  
Sacred

**WEX AND MODELLING CARVERS ●●●**



213-0366  
Le Cron



213-0367  
Le Cron



213-0368  
Vehe

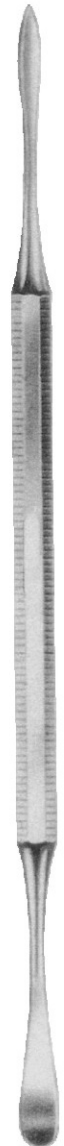

213-0369  
Beale



213-0370  
Roach



213-0371  
Le cron



213-0372  
Le cron



213-0373  
Gritman



●●● WEX AND MODELLING CARVERS



213-0374  
Fig. 1  
P. K.thomas



213-0375  
Fig. 2  
P. K.thomas



213-0376  
Fig. 3  
P. K.thomas



213-0377  
Fig. 4  
P. K.thomas



213-0378  
Fig. 5  
P. K.thomas

**WAX KNIVES ●●●**



214-0001  
Fig. 1  
Fahnenstock  
12.5 cm

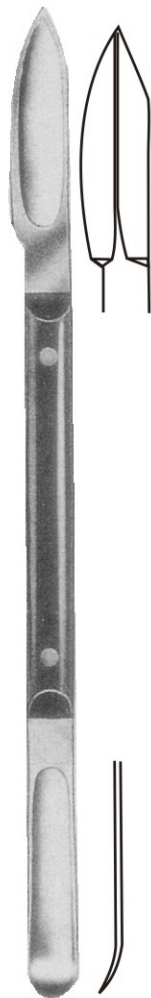

214-0002  
Fig. 1  
Lessmann  
12.5 cm



214-0003  
Fig. 1  
Con Scodelina

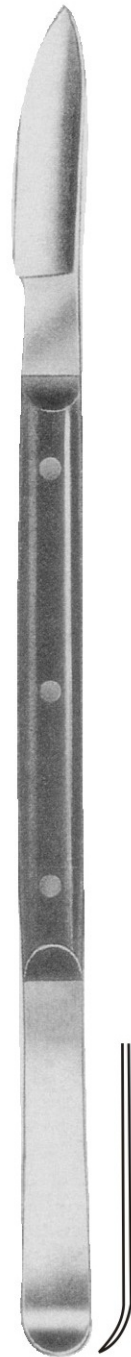

214-0004  
Fig. 2  
Fehnenstock



214-0005  
Fig. 2  
Lessmann

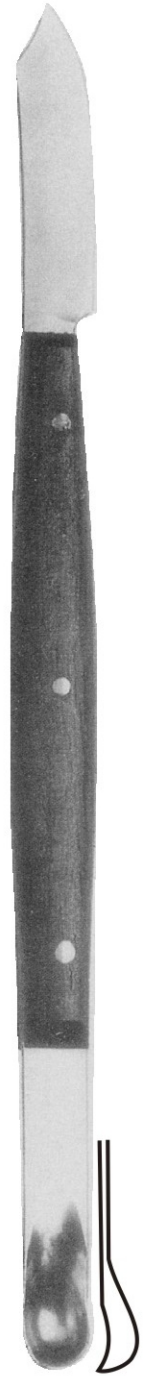

214-0006  
Fig. 2  
Con Scodelina

●●● SPATULAS FOR PLASTER AND ALGINATE

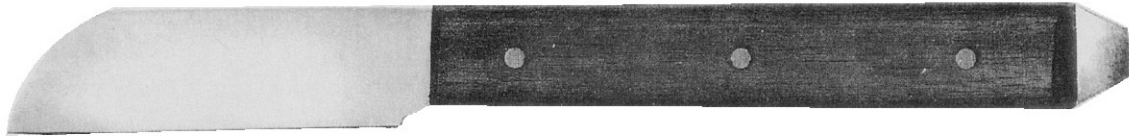

214-0007  
cm 17

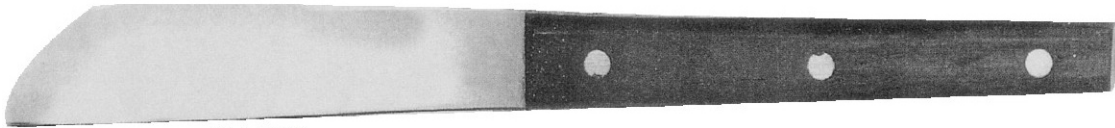

214-0008  
cm 17 Gritman

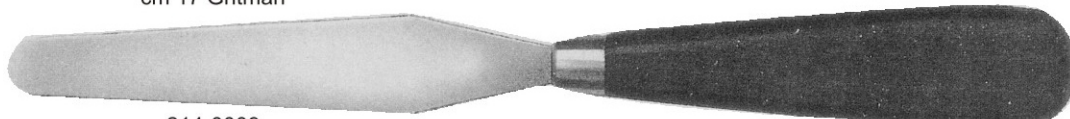

214-0009  
cm 19.5

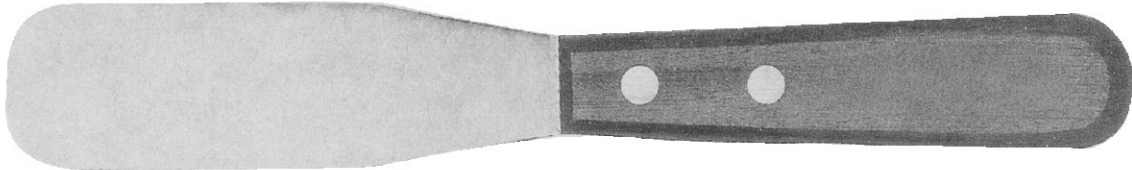

214-0010  
cm 21.5

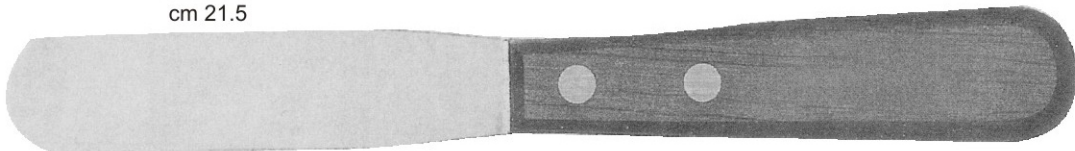

214-0011  
cm 20.5

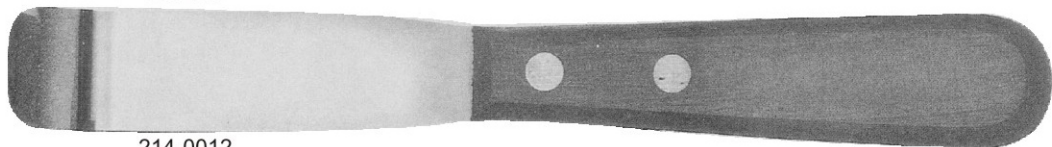

214-0012  
cm 19.5

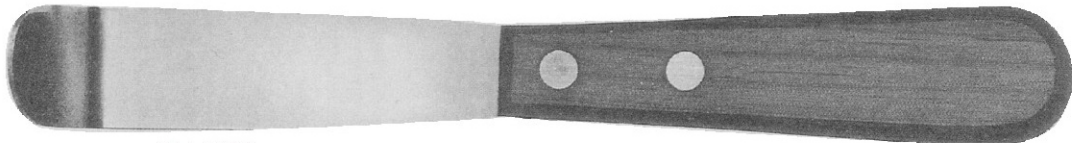

214-0013  
cm 20

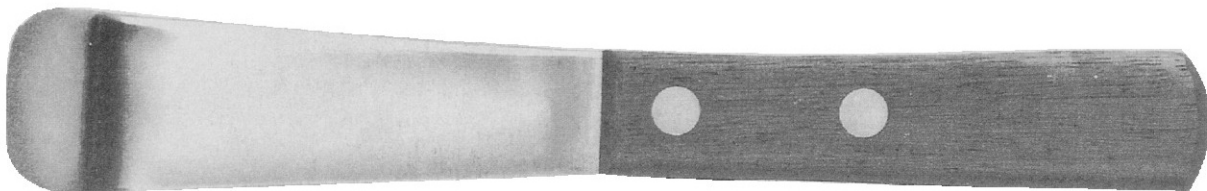

214-0014  
cm 22.5



**AMALGAM CARRIERS** ●●●

Ø1.5 mm

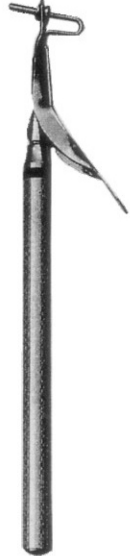

215-0001  
Small

Ø2 mm



215-0002  
Medium

Ø2.5 mm



215-0003  
Large

Ø3 mm



215-0004  
Jumbo



215-0005  
Jumbo  
Amalgam Well

Ø2 mm

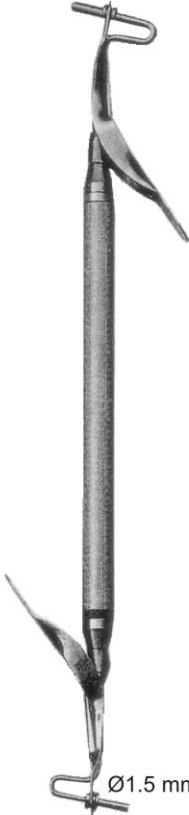

215-0006  
Medium Small

Ø2 mm



215-0007  
Medium Large

Ø2 mm

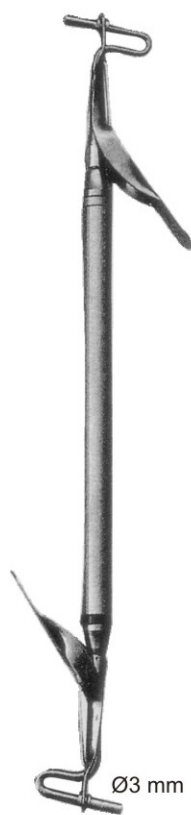

215-0008  
Medium Jumbo

Ø1.5 mm



Ø1.5 mm

Ø2.5 mm



Ø2.5 mm

Ø3 mm



Ø3 mm



215-0009

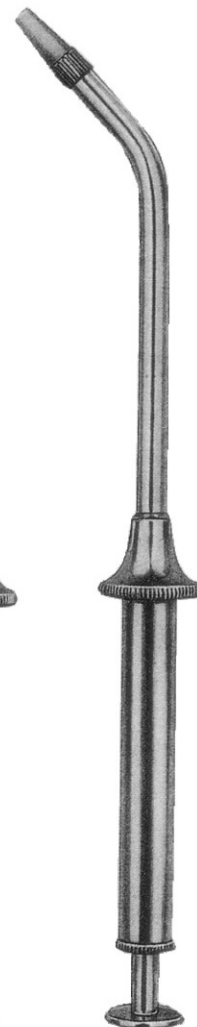

215-0010

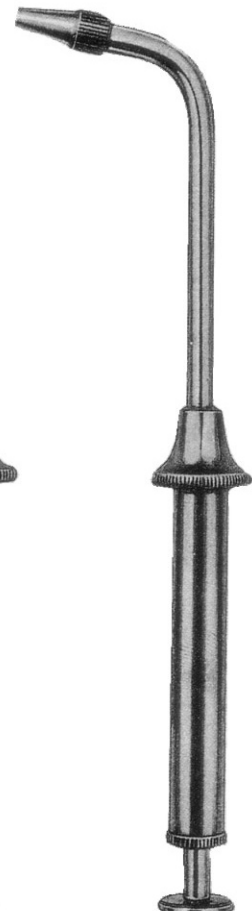

215-0011



●●● DENTAL CARTRIDGE SYRINGES



215-0012



215-0013



215-0014



215-0015



215-0016



215-0017



215-0018



215-0019

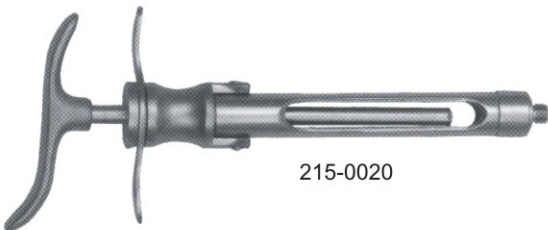

215-0020



215-0021

**DENTAL CARTRIDGE SYRINGES ●●●**



215-0022



215-0023

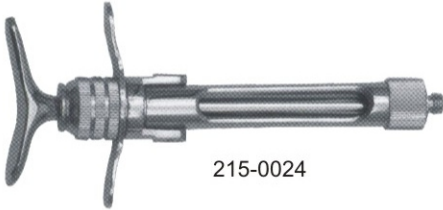

215-0024

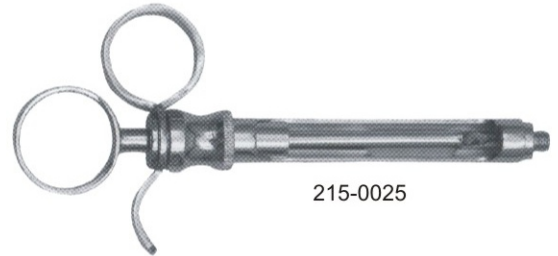

215-0025

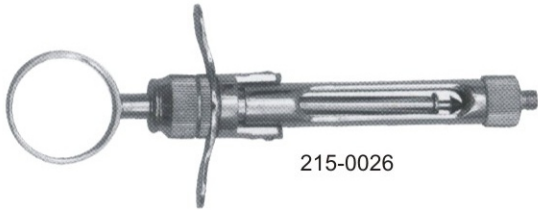

215-0026



215-0027

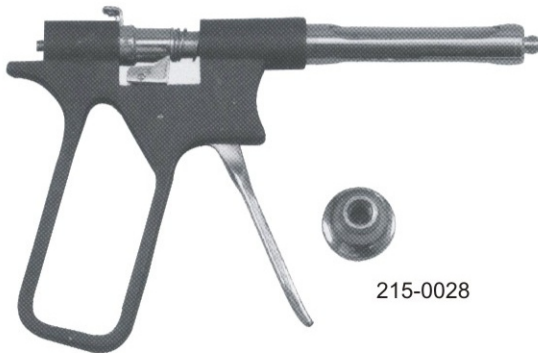

215-0028



215-0029



215-0030

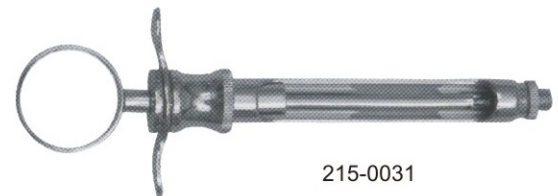

215-0031

● ● ● CHIP BLOWERS, WATER SYRINGES

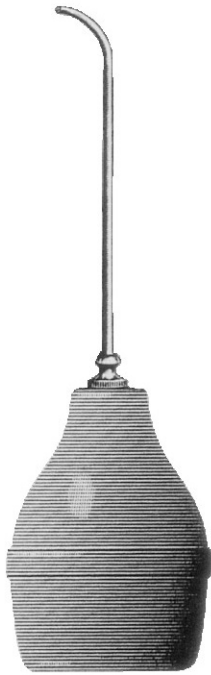

Chip blower

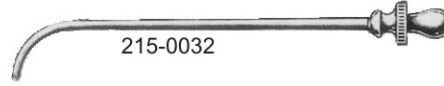

215-0032

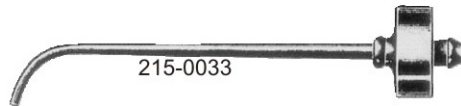

215-0033

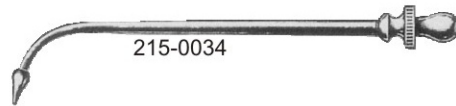

215-0034

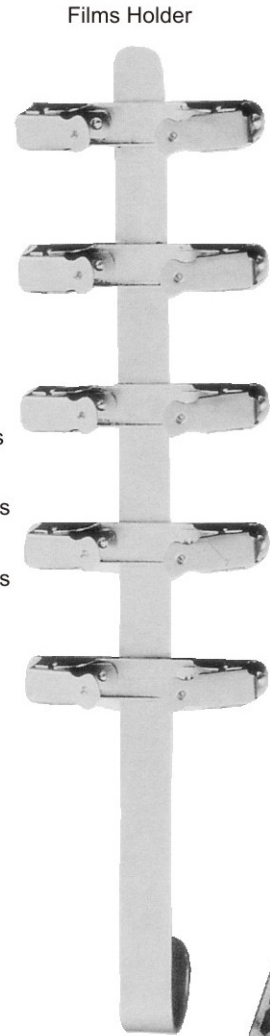

Films Holder

215-0035  
For 6 Films

215-0036  
For 10 Films

215-0037  
For 14 Films

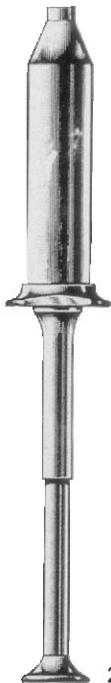

215-0038  
Water Syringe

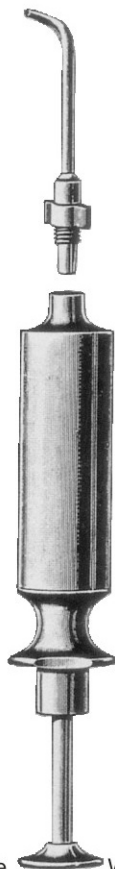

215-0039  
Water Syringe

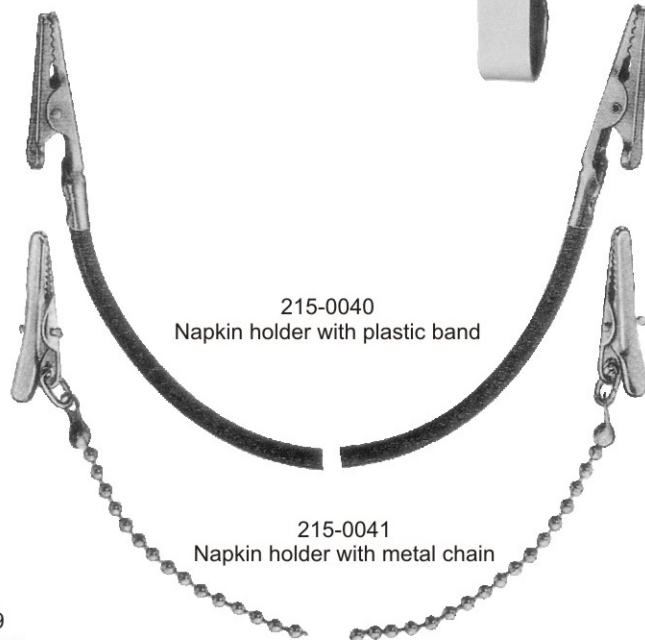

215-0040  
Napkin holder with plastic band

215-0041  
Napkin holder with metal chain

**MATRIX RETAINERS ●●●**

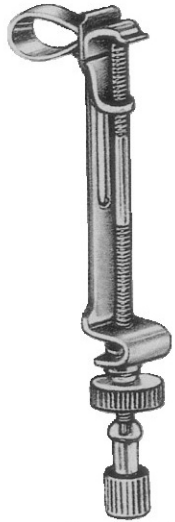

215-0042-5mm  
215-0043-6mm  
215-0044-7mm  
Ivory

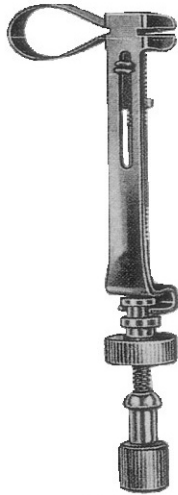

215-0045  
Ivory 8 N

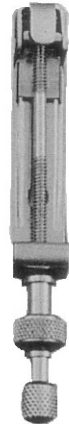

215-0046  
Ivory 8



215-0047  
Siqveland-narrow  
215-0048  
Siqveland-wide

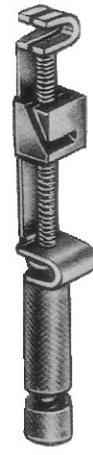

215-0049  
Fig. 1  
Toffemire-universal

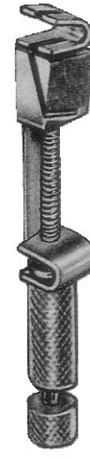

215-0050  
Fig. 2  
Toffemire-senior



215-0051  
Fig. 3  
Toffemire-junior

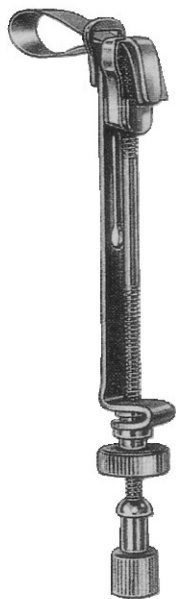

215-0052  
Fig. 2  
Didher 8

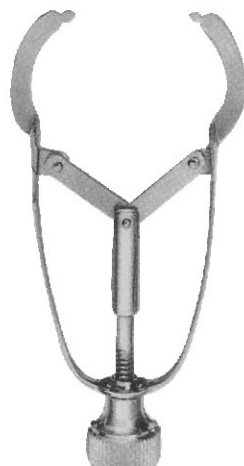

215-0053  
Ivory

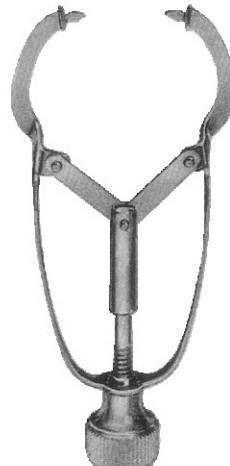

215-0054  
Ivory



215-0055  
Ivory separator



●●● CROWN INSTRUMENTS

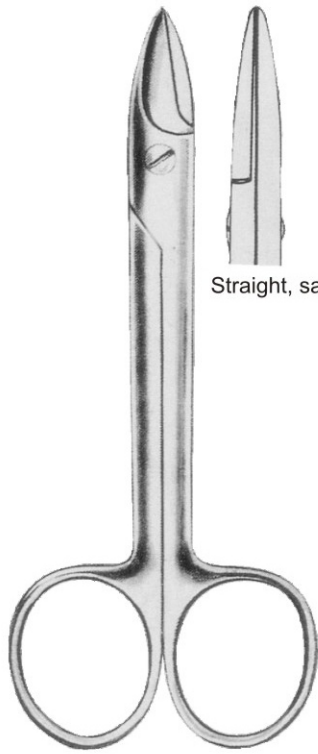

Straight, saw edge

215-0056  
Fig.1  
10.5cm

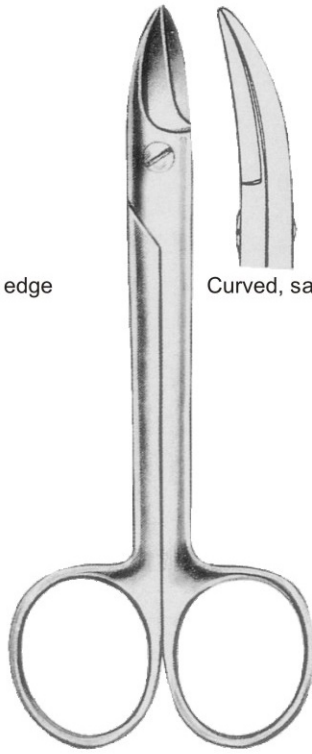

Curved, saw edge

215-0057  
Fig.2  
10.5cm

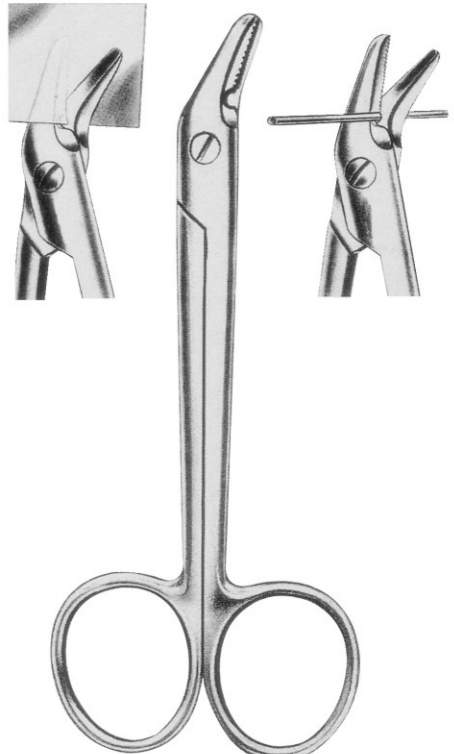

215-0058  
Universal  
12cm

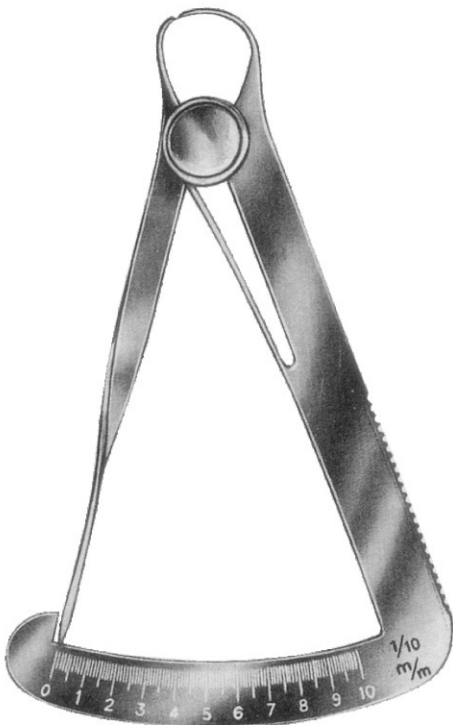

215-0059  
Lwanson



215-0060  
Fig.3  
Crown spreaders



Universal

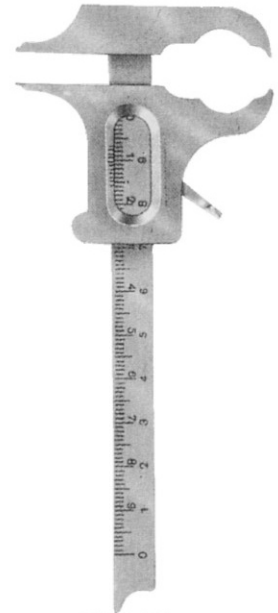

215-0061  
Boley  
14cm

**CROWN REMOVERS ●●●**

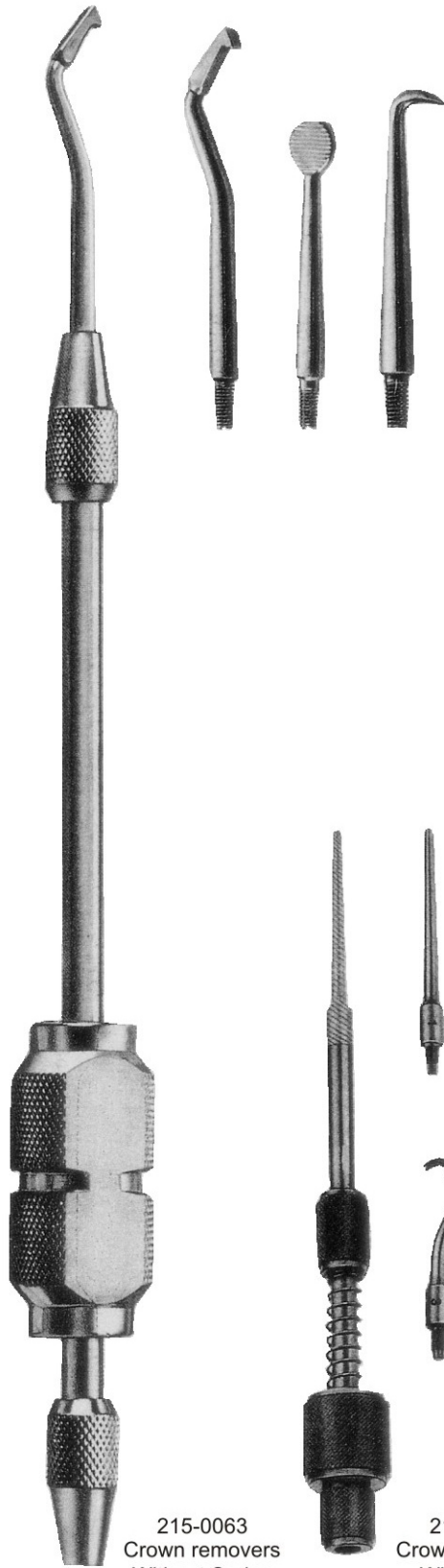

215-0063  
Crown removers  
Without Spring

215-0064  
Crown removers  
With Spring

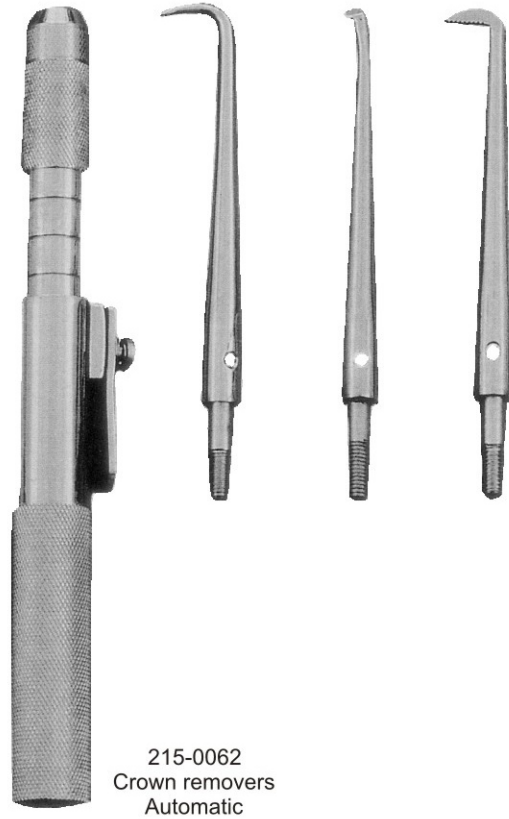

215-0062  
Crown removers  
Automatic

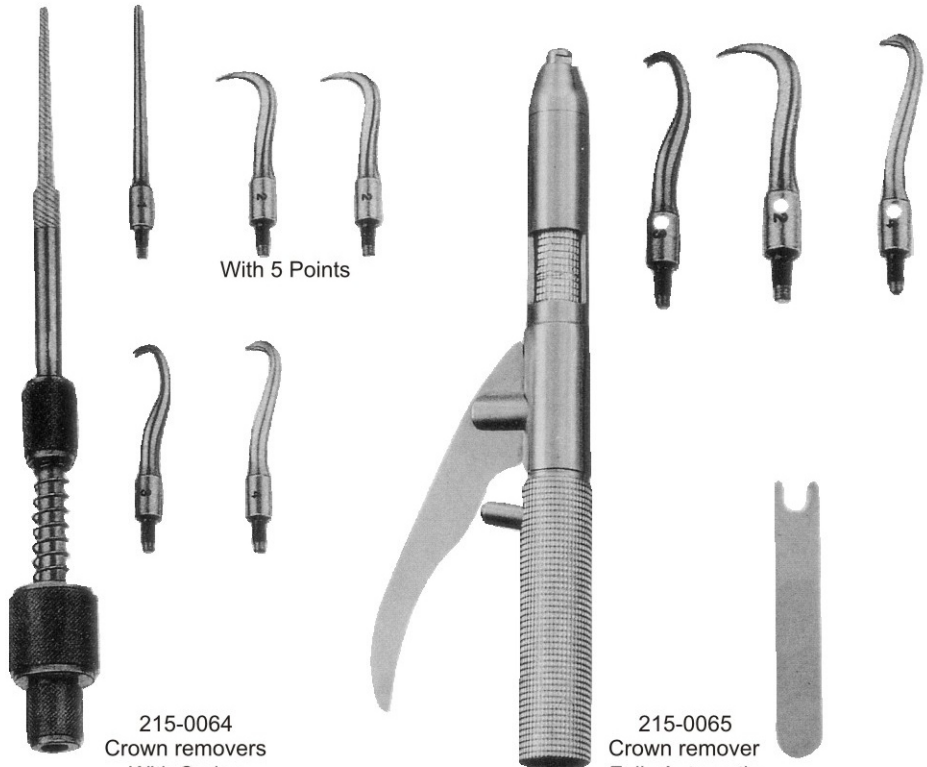

With 5 Points

215-0065  
Crown remover  
Fully Automatic

●●● CROWN INSTRUMENTS

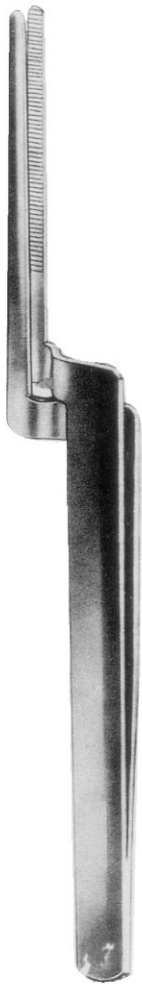

215-0066  
Articulating Paper Forcep  
15cm



215-0067  
Miller  
15cm



215-0068  
Crown Spreader



215-0069  
Vernier Gauge Caliper  
0mm to 80mm

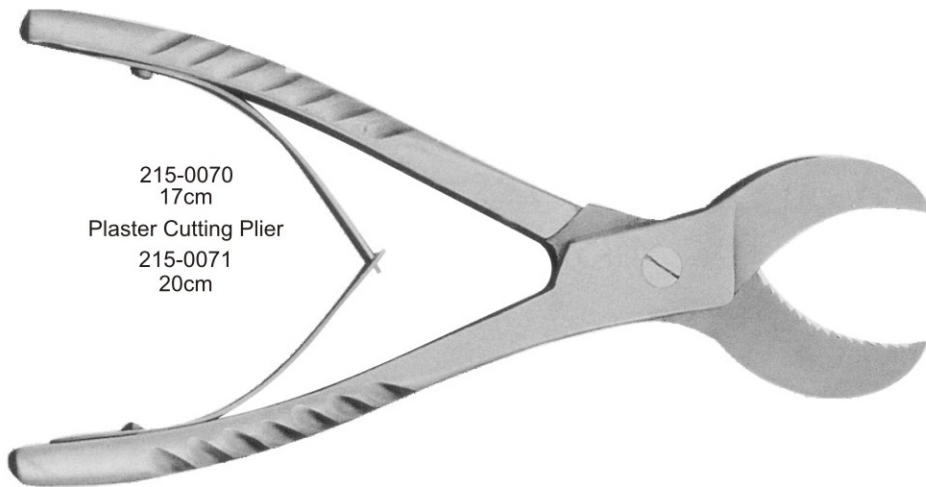

215-0070  
17cm  
Plaster Cutting Plier  
215-0071  
20cm



215-0072  
Arch Turret with 5 wire-slots  
.016", .017", .018", .020" and .022"



**IMPRESSION TRAYS ●●●**

**Available in Set of 8**  
**Code # Set - A001**

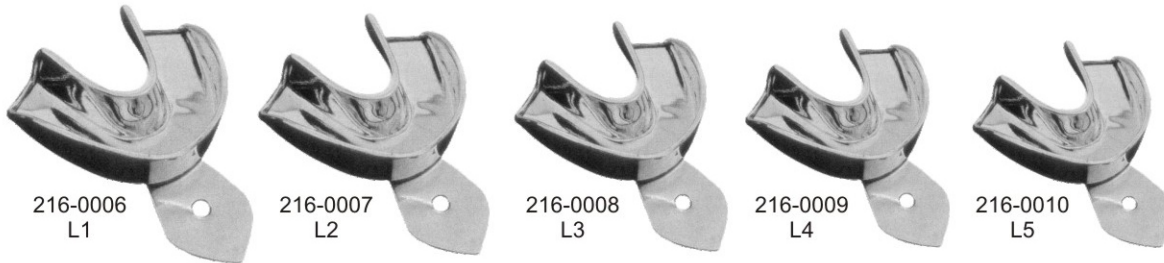
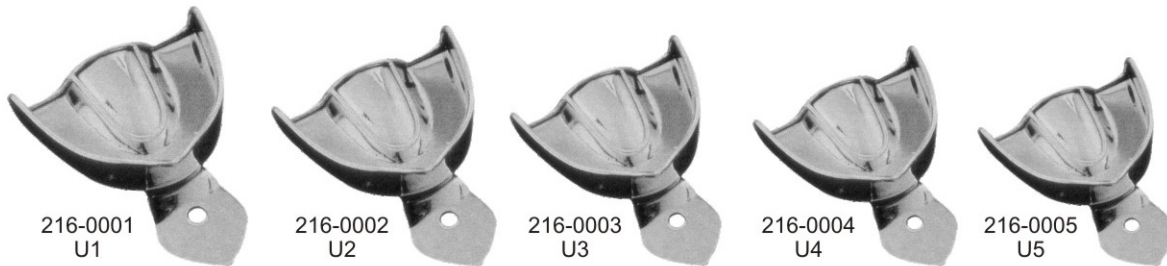

All the above impression trays are available in these 4 sizes

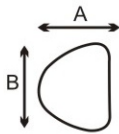

UPPER		U1	U2	U3	U4	U5
	A		62	60	53	54
B		63	75	73	69	68

All Dimension are in mm

Lower		L1	L2	L3	L4	L5
	A		63	61	57	60
B		82	81	78	74	71

All Dimension are in mm

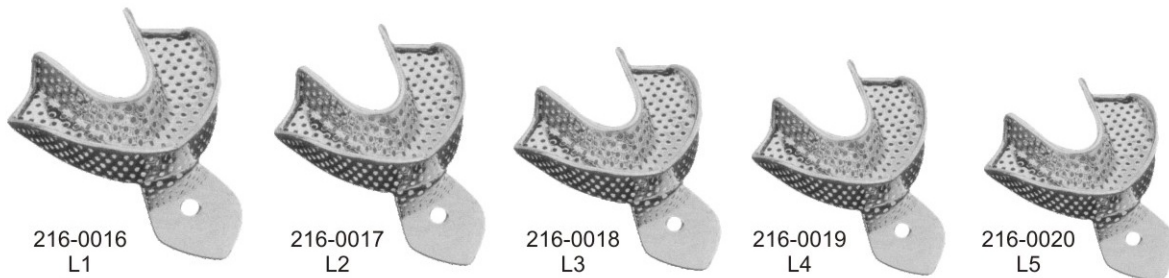
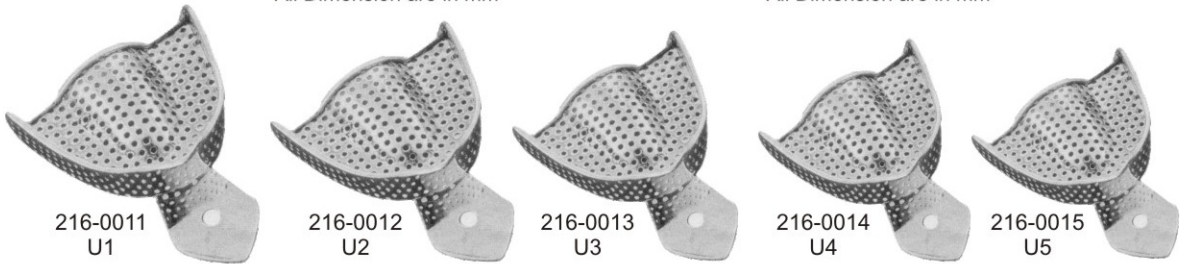
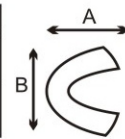

**Available in Set of 8**  
**Code # Set - A002**



●●● IMPRESSION TRAYS

**Available in Set of 8**  
**Code # Set - A003**

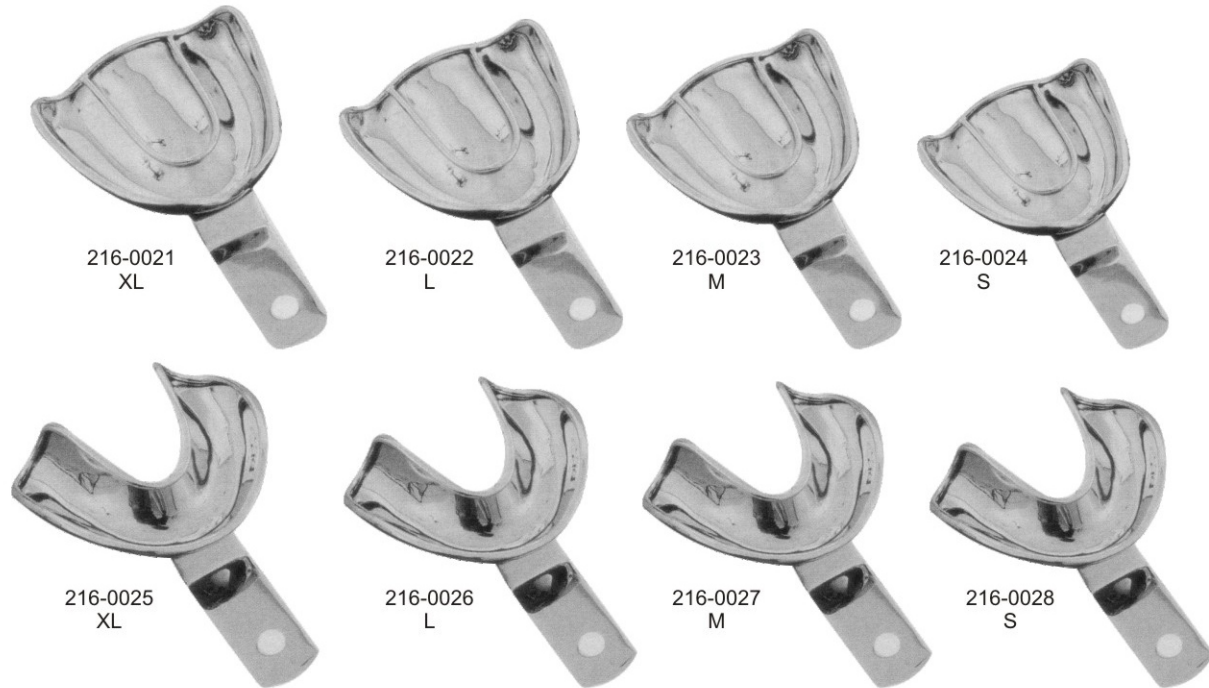

All the above impression trays are available in these 4 sizes

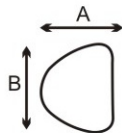

UPPER		XL	L	M	S
	A	70	67	64	60
B	79	78	70	73	

All Dimension are in mm

LOWER		XL	L	M	S
	A	64	64	60	57
B	86	70	73	70	

All Dimension are in mm

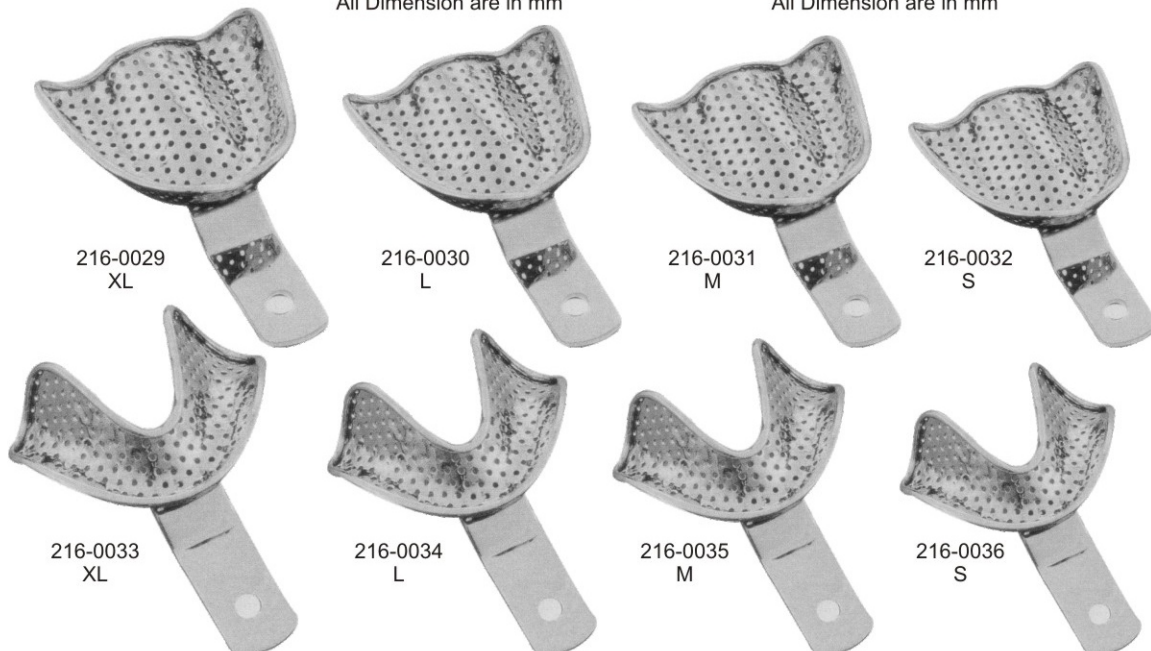
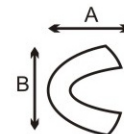

**Available in Set of 8**  
**Code # Set - A004**

**IMPRESSION TRAYS ●●●**

**Available in Set of 6**  
**Code # Set - A005**



216-0037  
U1



216-0038  
U2



216-0039  
U3



216-0040  
L1



216-0041  
L2



216-0042  
L3

All the above impression trays are available in these 4 sizes

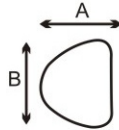

LOWER		L1	L2	L3
	A	67	64	57
B	81	71	70	

All Dimension are in mm

LOWER		L1	L2	L3
	A	60	57	64
B	84	79	76	

All Dimension are in mm

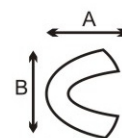

216-0043  
U1



216-0044  
U2



216-0045  
U3



216-0046  
L1



216-0047  
L2



216-0048  
L3

**Available in Set of 6**  
**Code # Set - A006**

●●● IMPRESSION TRAYS

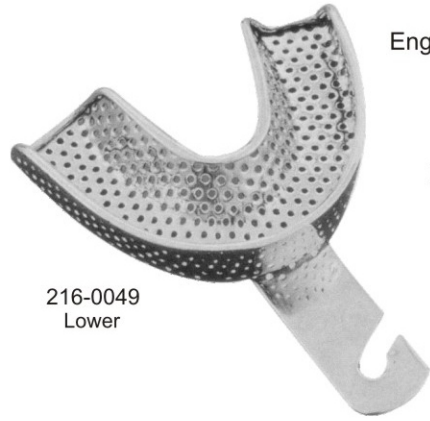

216-0049  
Lower

English Pattern



216-0050  
Upper

Mesh type

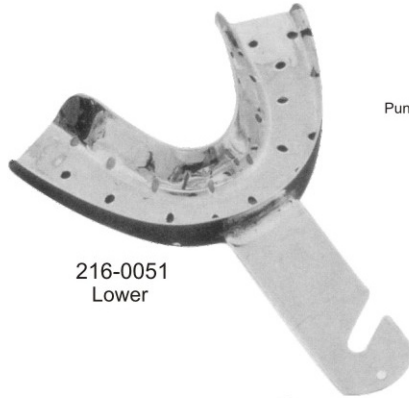

216-0051  
Lower

Punched Type



216-0052  
Upper



216-0053  
Lower

Solid Type



216-0054  
Upper

All the above impression trays are available in these 4 sizes

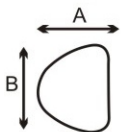

UPPER	Size	A	B	C
	0	67	50	12
	1	72	51	13
	2	78	55	15
	3	80	58	15

All Dimension are in mm

LOWER	Size	A	B	C
	0	70	50	12
	1	77	51	13
	2	7	55	15
	3	80	50	15

All Dimension are in mm



**IMPRESSION TRAYS ●●●**

**Available in Set of 8**  
**Code # Set - A007**

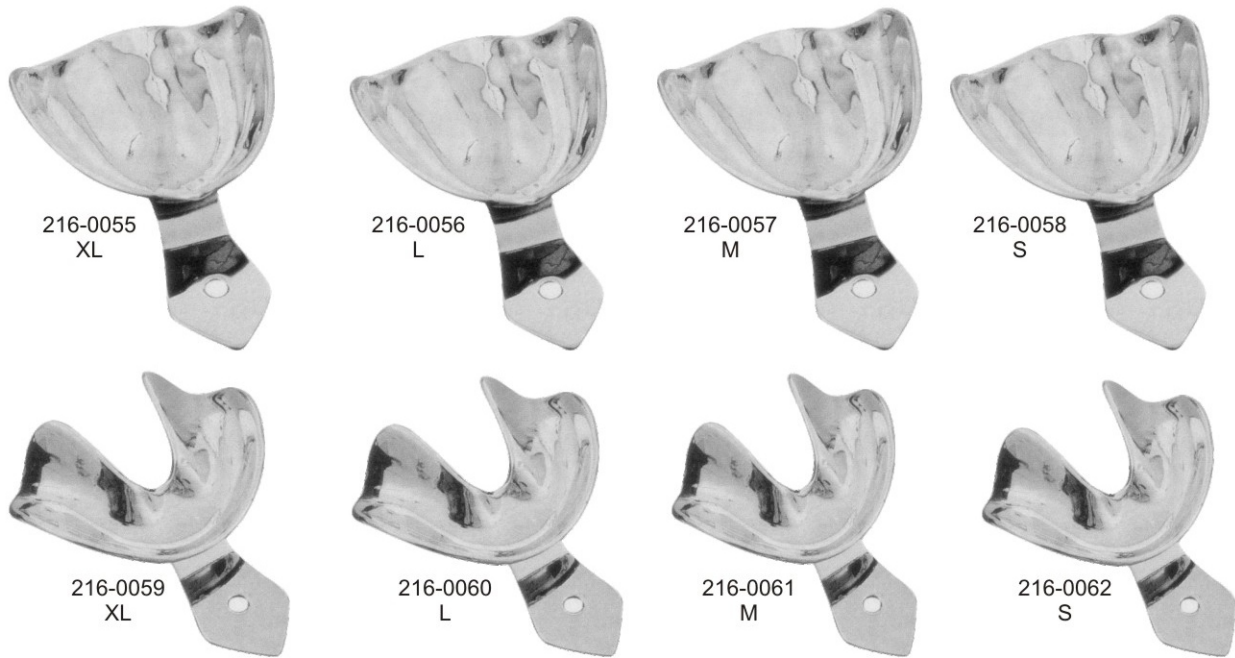

All the above impression trays are available in these 4 sizes

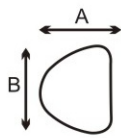

UPPER		XL	L	M	S
	A		70	67	64
B		79	78	70	73

All Dimension are in mm

LOWER		XL	L	M	S
	A		64	64	60
B		86	70	73	70

All Dimension are in mm

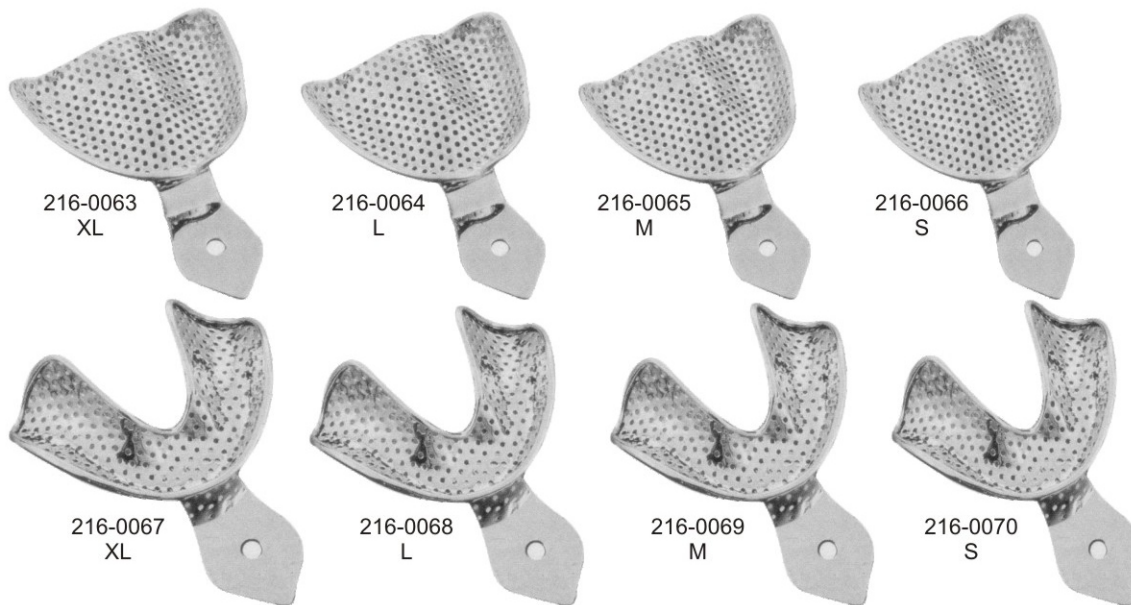
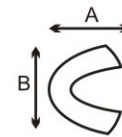

**Available in Set of 8**  
**Code # Set - A008**



●●● IMPRESSION TRAYS

**Available in Set of 8**  
**Code # Set - A009**

For crown & bridgework Impression Trays

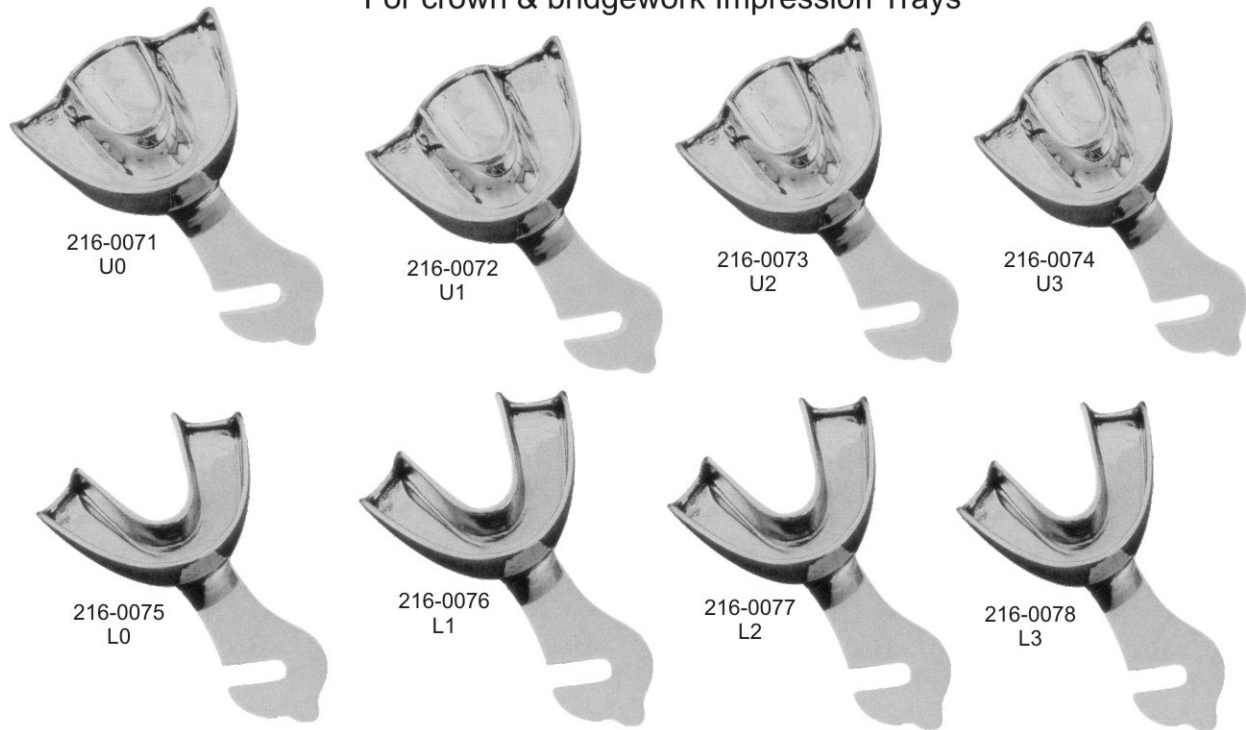

Upper Sizes 0,1,2,3,  
Depth of the tray 19,9 mm  
Height of palate 12,5 mm

Lower Sizes 0,1,2,3,  
Depth of the tray 12,9 mm

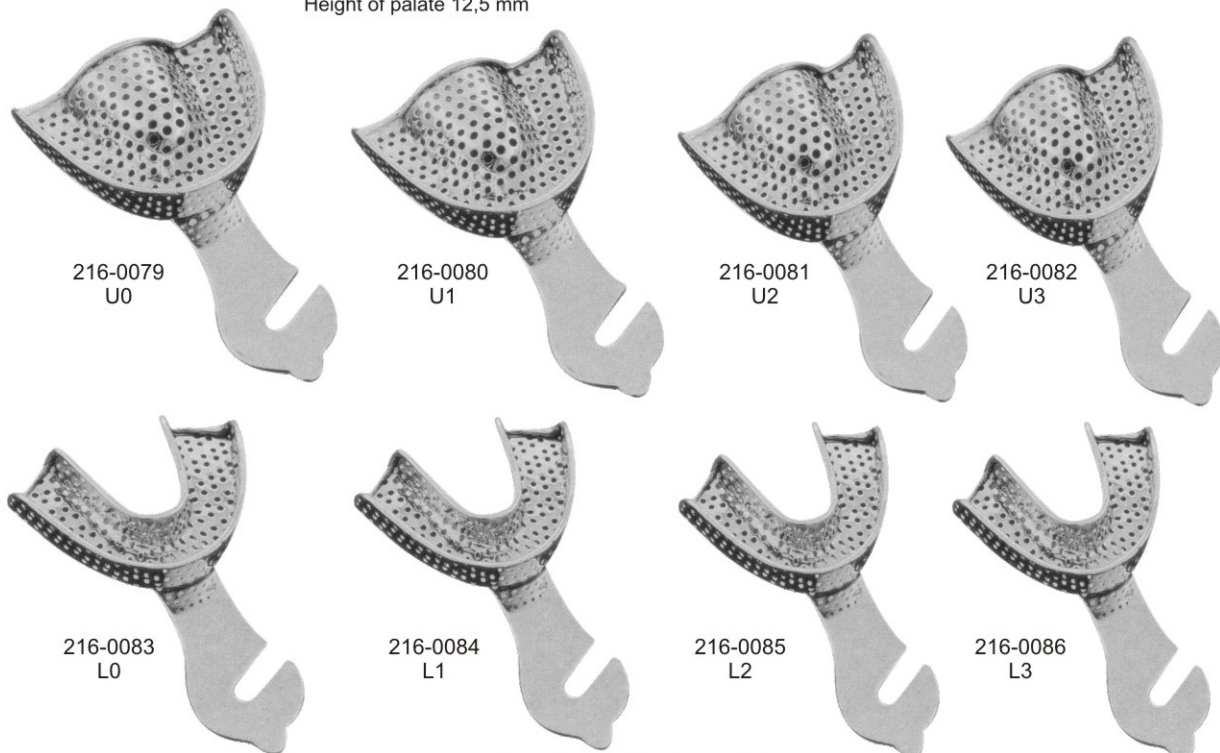

**Available in Set of 8**  
**Code # Set - A010**

**IMPRESSION TRAYS ●●●**

Impression trays for crown & bridge work



216-0087  
U1P



Solid

216-0088  
L1P



216-0089  
U1P



Perforated

216-0090  
L1P

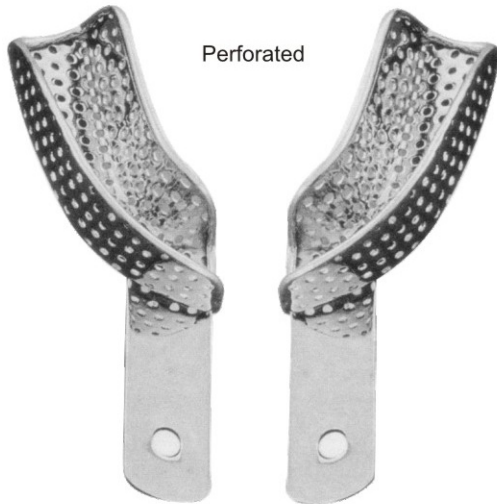

Perforated

216-0091  
For upper right jaw  
For lower left jaw

216-0092  
For upper left jaw  
For lower right jaw



216-0093  
Adjustable  
Perforated



216-0094  
Adjustable  
Solid

Available in 4 Sizes  
1.....44 mm  
2.....55 mm  
3.....60 mm  
4.....65 mm

Also available in Solid pattern

●●● INSTRUMENTS TRAYS

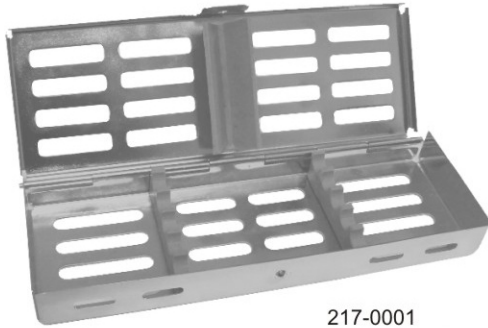

217-0001  
Scalor Sterilizing Tray  
For 5-pcs  
18 x 6 x 2 cm



217-0002  
Scalor Sterilizing Tray  
For 5-pcs  
18 x 8.5 x 2 cm



217-0003  
Scalor Sterilizing Tray  
For 10-pcs  
18 x 12.5 x 2 cm



217-0004  
Scalor Sterilizing Tray  
For 10-pcs  
18 x 14 x 2 cm

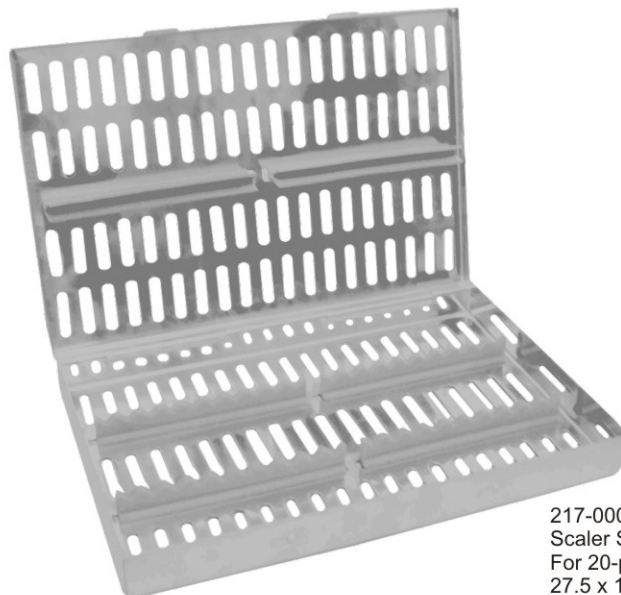

217-0005  
Scalor Sterilizing Tray  
For 20-pcs  
27.5 x 18 x 2.5 cm



**HOLLOW WARE ITEMS ●●●**

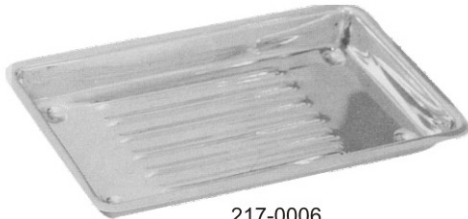

217-0006  
Scallers Tray

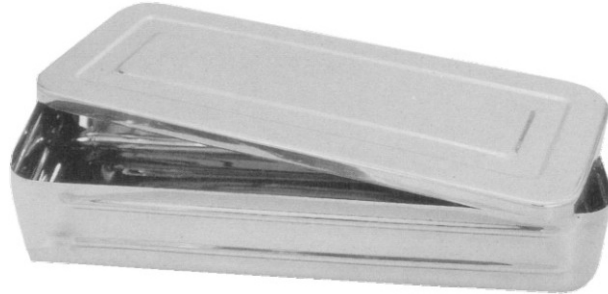

Instruments Box

217-0007  
10"×6"×2"  
217-0008  
12"×8"×2½"  
217-0009  
16"×12"×4"

217-0010  
8"×6"×2"  
217-0011  
10"×8"×2"  
217-0012  
12"×8"×2½"  
217-0013  
12"×10"×2½"  
217-0014  
14"×10"×2½"  
217-0015  
14"×12"×2½"



Instruments Tray with Lid



Instruments Tray without Lid

217-0016  
8"×6"×2"  
217-0017  
10"×8"×2"  
217-0018  
12"×8"×2½"  
217-0019  
12"×10"×2½"  
217-0020  
14"×10"×2½"  
217-0021  
14"×12"×2½"



217-0022  
8"×3"×1½"  
Instruments Box

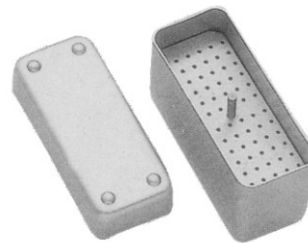

217-0023  
Endodontic box

217-0024  
10"×6"×2"  
217-0025  
12"×8"×2½"  
217-0026  
16"×12"×4"



Instruments Box



●●● HOLLOW WARE ITEMS

	Ø	Depth
217-0027	2"	2"
217-0028	4"	2"
217-0029	5½"	2½"
217-0030	6"	2¾"
217-0031	7"	3½"
217-0032	8"	3½"
217-0033	10"	4"



Lotion Bowl



Kidney Trays

217-0034	6"
217-0035	8"
217-0036	10"
217-0037	12"



217-0038  
6" x 9"  
Sterilizing Drum  
217-0039  
8" x 12"



217-0040  
10" x 10"  
Sterilizing Drum



217-0041  
Cotton Holder



217-0042  
80 x 35 mm  
Medicine Cup  
217-0043  
125 x 60 mm

217-0046	25 x 80 mm
217-0047	30 x 100 mm
217-0048	75 x 173 mm
217-0049	100 x 200 mm



217-0044  
Spirit Lamp



217-0045  
Spirit Lamp

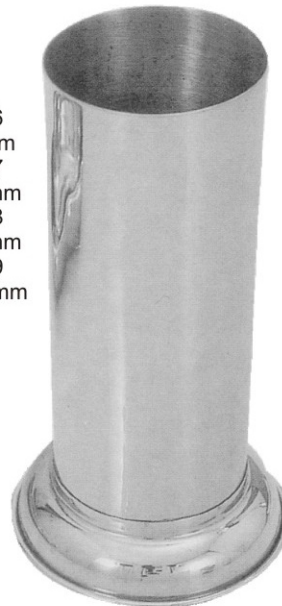

Forcep Jar



217-0050  
5cm x 15cm  
Forcep Jar  
217-0051  
5cm x 10cm

**RUBBER DAM CLAMPS ●●●**

**Molar Clamps Winged**



218-0001  
Fig. 30



218-0002  
Fig. 31



218-0003  
Fig. 51



218-0004  
Fig. 138



218-0005  
Fig. 139



218-0006  
Fig. 15



218-0007  
Fig. 18



218-0008  
Fig. 24



218-0009  
Fig. 25



218-0010  
Fig. 26



218-0011  
Fig. 28

**Bicuspid Clamps Winged**



218-0012  
Fig. 206



218-0013  
Fig. 207



218-0014  
Fig. 208



218-0015  
Fig. 209



218-0016  
Fig. 22



218-0017  
Fig. 27



218-0018  
Fig. 29

**Molar Clamps Winged**



218-0019  
Fig. 26A



218-0020  
Fig. 28A



218-0021  
Fig. 30A



218-0022  
Fig. 31A



218-0023  
Fig. 51A

**Bicuspid Clamps Winged**



218-0024  
Fig. 27



218-0025  
Fig. 29



218-0026  
Fig. 60

**Molar Clamps Winged**



218-0027  
Fig. 200



218-0028  
Fig. 201



218-0029  
Fig. 202



218-0030  
Fig. 203



218-0031  
Fig. 204



218-0032  
Fig. 205

**Labial Clamps Winged**



218-0033  
Fig. 210



218-0034  
Fig. 211



218-0035  
Fig. 212

●●● ARTICULATOR

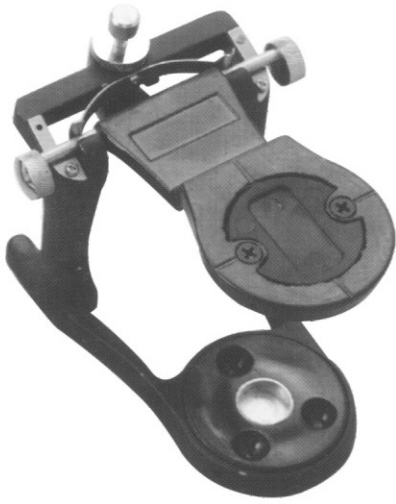

219-0001



219-0002



219-0003



219-0004

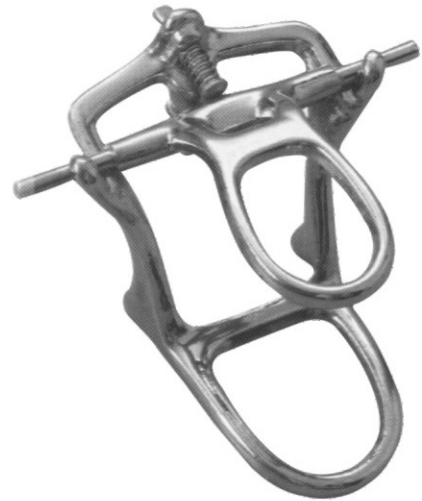

219-0005



219-0006



IMPRESSION TRAYS SETS ●●●



220-0001

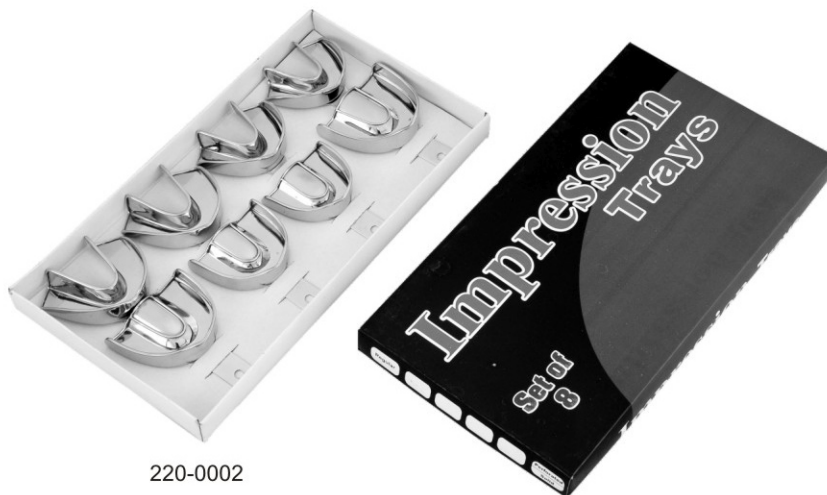

220-0002



220-0003



●●● IMPRESSION TRAYS SET

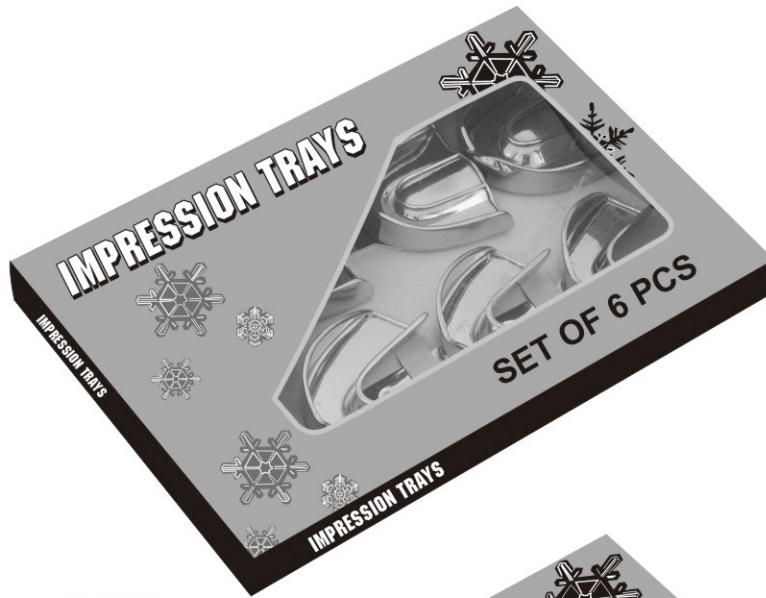

220-0004



220-0005

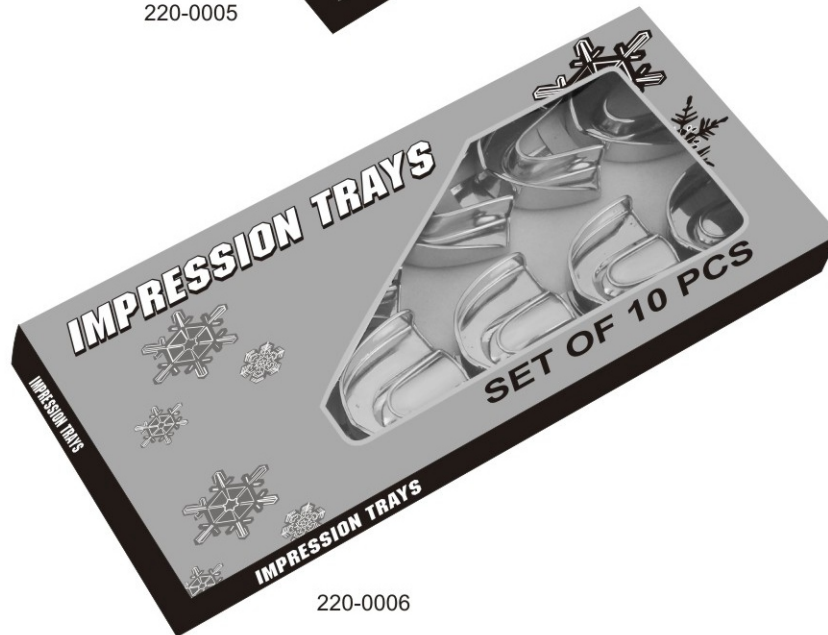

220-0006

**INSTRUMENTS PACKINGS ●●●**



220-0007



220-0008



220-0009



220-0010



220-0011



220-0012



220-0013



220-0014



220-0015

●●● INSTRUMENTS PACKINGS



220-0016

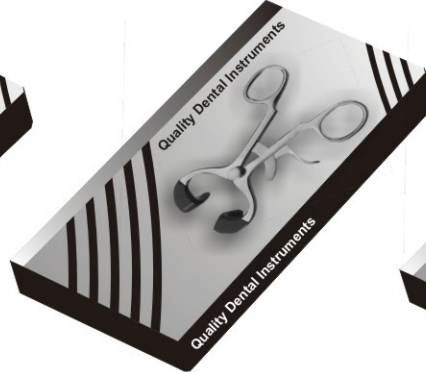

220-0017

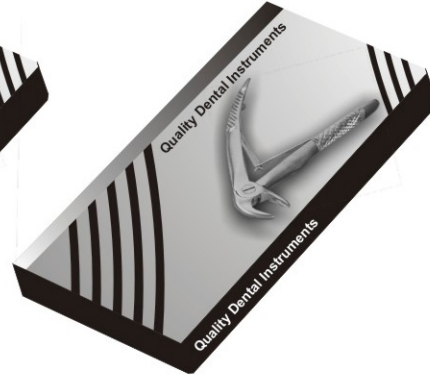

220-0018



220-0019



220-0020



220-0021



220-0022



220-0023







NEW  
EDITION

DENTAL INSTRUMENTS



**U MED**  
**INSTRUMENTS**



**DENTAL**  
**INSTRUMENTS**